

激情成就梦想

质量铸就辉煌

Passion makes dream come true

Quality helps enterprise achieve success



青岛越海机械有限公司



**SAFETYLIFT**  
MACHINERY CO., LTD  
www.safetylift.cn

地址：青岛即墨市华山镇省级高新技术  
产业开发区龙华一路东侧  
电话：0532-88893599 88894100  
传真：0532-88893476 88965816  
手机：13954257397 (微信)  
网址：www.safetylift.cn  
www.safetyliftcom.com  
邮箱：safetylift@china.com  
邮编：266216



青岛越海机械有限公司



**SAFETYLIFT**  
MACHINERY CO., LTD  
www.safetylift.cn

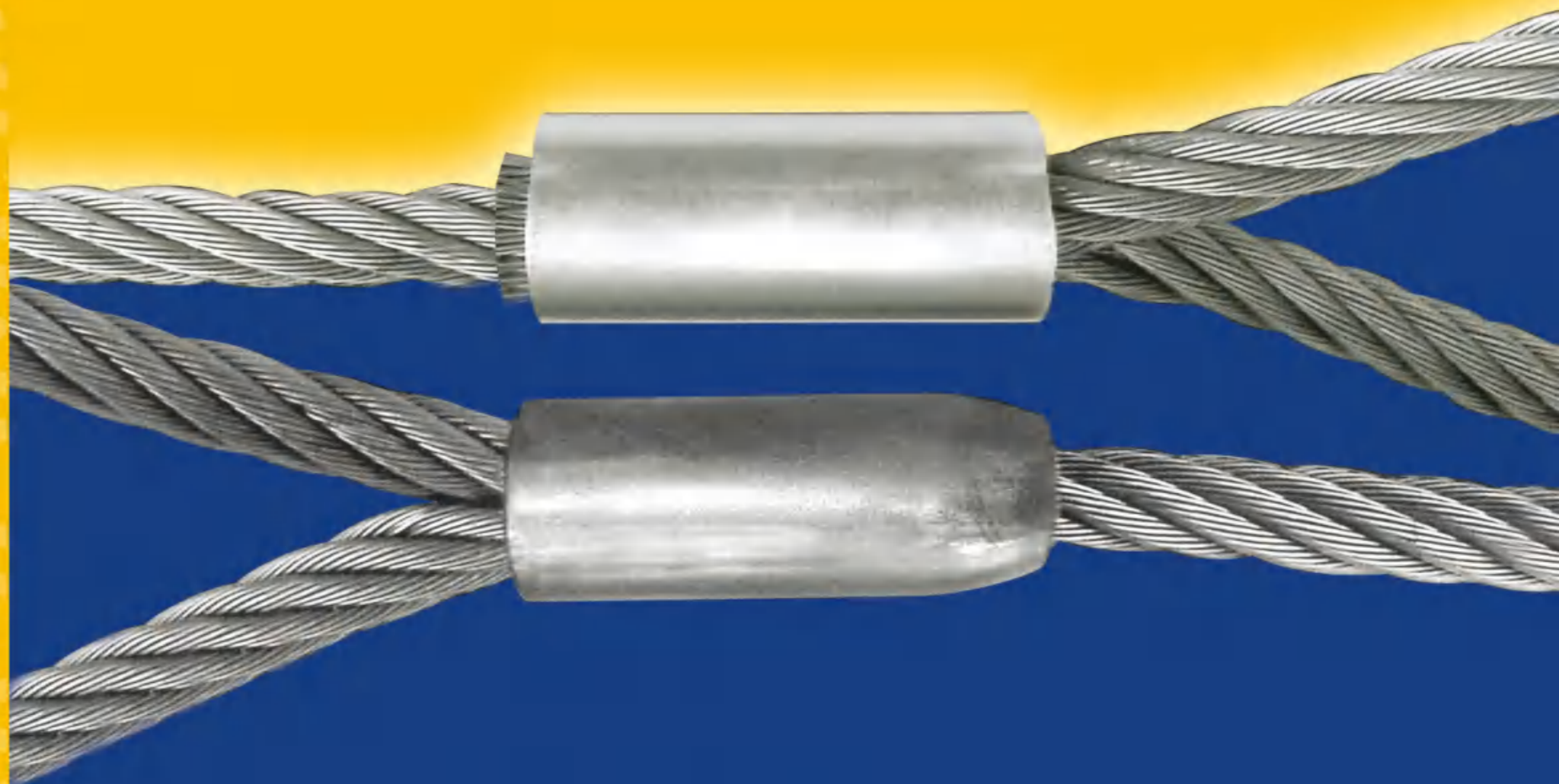

青岛海波扬金属制品有限公司  
QINGDAO H-QUALITY INDUSTRIES CO., LTD



**FASTENAL**



青岛越海机械有限公司成立于1998年，座落在青岛即墨市华山镇省级高新技术产业开发区，占地面积100亩，目前已完成的建筑面积为29000平方米，公司毗邻华山高尔夫球场，紧靠204国道和威乌高速，风景秀美，环境宜人，交通便利，人杰地灵。

我司的主要产品是钢丝绳铝套、铜套、钢套及其它配件，同时向国内外客户提供各种规格和用途的钢丝绳组合件，压制品和吊具。公司拥有500吨，1000吨，2000吨，5000吨挤压机各一台，另有锻造机、拉拔机、液压压制机，冲床，锯床、滚丝机、铣床、车床等生产设备100多台。产品质量上乘，设计精美，畅销全球50多个国家和地区。

激情成就梦想，质量铸就辉煌！我们对自己的要求是：认真—勤奋—总结，永不封闭自己的思路，我们对客户的承诺是：诚信—优质—低价，共同追求生意的极致。我们已经是最好的钢丝绳组合件，压制品和吊具供应商，希望在您的支持和厚爱下发展成为全球一流的优秀供应商。

Qingdao Safetylift Machinery Co., Ltd was founded in 1998, which is located in the Qingdao Jimo Huashan Town provincial Hi-Tech Industrial Development Zone. It covers an area of 66,600 m<sup>2</sup> and the bring into service workshop is 29,000 m<sup>2</sup>. The company adjoins to the Huashan Golf Course, abuts 204 National Highway and Weihai-Wuhai Expressway. So the scenery is beautiful, the environment is pleasant, the traffic is convenient and the place is remarkable.

The main products of our company are Aluminium Sleeves, Copper Sleeves, Steel Ferrules and other fittings for Wire Rope. Meanwhile, We have provided Wire Rope Assembles, Pressing Products and Lifting Tools to our customers all over the world. There are 500T, 1000T, 2000T and 5000T Extruding Machines, Pressing Machines in our jobsite, in addition that we also have more than 100 sets' equipments, such as Forging Machines, Drawing Machines, Hydraulic Press Machines, Forming Machines, Cutting Machines, Thread Rollers, Milling Machines, Lathes, and so on. The products with high quality and fine design sell well in more than 50 countries and areas of the world.

Passion makes dream come true, quality helps enterprise achieve success. Our principles to ourselves are: Earnest-Industrious-Improvement, never limiting our minds. Our pledges to our customers are: Honest-High Quality-Attractive Price, always meeting your demands. We have already been the best supplier of the Wire Rope Assembles, Pressing Products and Lifting Tools, and hope to be the global first-class supplier under your deep affection and support.



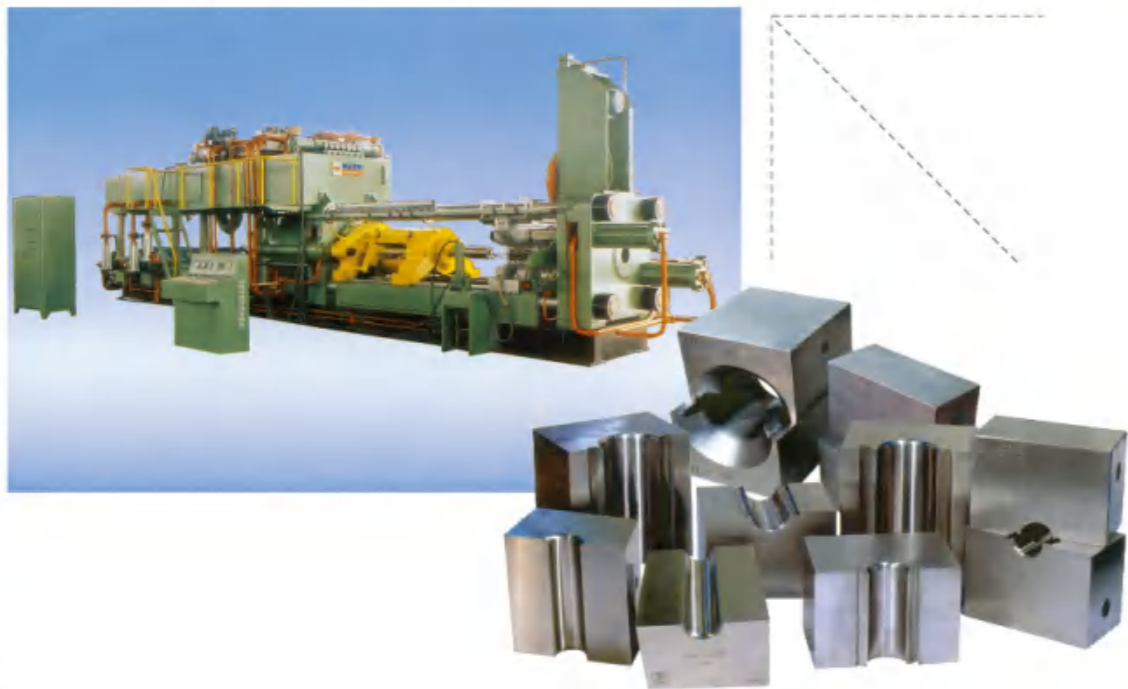
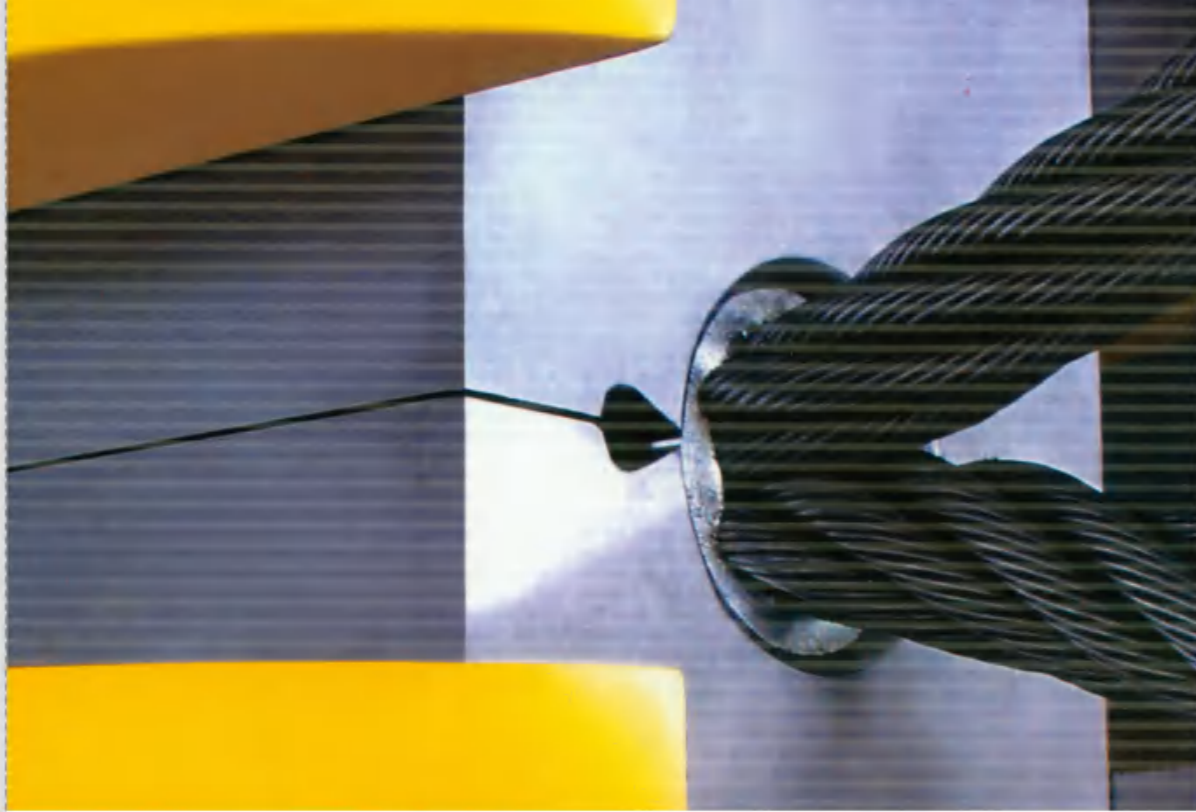



## 德式椭圆形铝套

### Aluminium Ferrules

#### Specification EN 13411-3 ( DIN 3093 )

SAFETYLIFT aluminum ferrules are manufactured per EN13411-3 (DIN 3093) from #0.8 to #150. For safety in fabrication and application, our ferrules are made of strictly material corresponding to the requirements of EN 13411-3 (DIN 3093) regarding material composition and mechanical properties.



PART NO.	FERRULE CODE.	A (mm)	B (mm)	S (mm)	L (mm)	WEIGHT Kgs/1000Pcs	L' (mm) GB 6946-93	WEIGHT'(GB) Kgs/1000Pcs
SL990008	0.8	1.0	2.0	0.55	5	0.052	-	-
SL990010	1	1.2	2.4	0.65	5	0.073	-	-
SL990015	1.5	1.7	3.4	0.75	6	0.136	-	-
SL990020	2	2.2	4.4	0.85	7	0.227	-	-
SL990025	2.5	2.7	5.4	1.05	9	0.443	10.5	0.517
SL990030	3	3.3	6.6	1.25	11	0.784	12.5	0.891
SL990035	3.5	3.8	7.6	1.5	13	1.291	14.5	1.440
SL990040	4	4.4	8.8	1.7	14	1.817	17	2.206
SL990045	4.5	4.9	9.8	1.9	16	2.586	19	3.071
SL990050	5	5.5	11.0	2.1	18	3.599	21	4.199
SL990060	6	6.6	13.2	2.5	21	5.989	25	7.130
SL990065	6.5	7.2	14.4	2.7	23	7.714	27.5	9.223
SL990070	7	7.8	15.6	2.9	25	9.741	29	11.30
SL990080	8	8.8	17.6	3.3	28	14.03	34	17.03
SL990085	8.5	9.3	18.6	3.5	30	16.86	36	20.23
SL990090	9	9.9	19.8	3.7	32	20.21	38	24.00
SL990100	10	10.9	21.8	4.1	35	27.00	42	32.40
SL990105	10.5	11.5	23.0	4.3	37	31.55	44	37.52
SL990110	11	12.1	24.2	4.5	39	36.58	46	43.15
SL990120	12	13.2	26.4	4.9	42	46.78	50	55.89
SL990130	13	14.2	28.4	5.4	46	61.02	55	72.95
SL990140	14	15.3	30.6	5.8	49	75.17	59	90.51
SL990150	15	16.4	32.8	6.3	53	94.90	63	112.8
SL990160	16	17.5	35.0	6.7	56	113.7	67	136.1
SL990180	18	19.6	39.2	7.6	63	162.9	76	196.6
SL990200	20	21.7	43.4	8.4	70	221.5	84	265.8
SL990220	22	24.3	48.6	9.2	77	297.5	92	355.5
SL990240	24	26.4	52.8	10.0	84	383.3	101	460.9
SL990260	26	28.5	57.0	10.9	91	489.5	109	586.4
SL990280	28	31.0	62.0	11.7	98	614.0	118	739.3
SL990300	30	33.1	66.2	12.5	105	750.5	126	900.6
SL990320	32	35.2	70.4	13.4	112	914.0	134	1094
SL990340	34	37.8	75.6	14.2	119	1102	143	1325
SL990360	36	39.8	79.6	15.0	126	1299	151	1557
SL990380	38	41.9	83.8	15.8	133	1521	160	1829
SL990400	40	44.0	88.0	16.6	140	1766	168	2119
SL990420	42	46.2	92.4	17.5	147	2054	176	2460
SL990440	44	48.4	96.8	18.3	154	2357	184	2816
SL990460	46	50.6	101.2	19.2	161	2705	192	3225
SL990480	48	52.8	105.6	20.0	168	3067	200	3651
SL990500	50	55.0	110.0	20.8	175	3459	208	4112
SL990520	52	57.2	114.4	21.6	182	3885	216	4610
SL990540	54	59.4	118.8	22.5	189	4366	224	5175
SL990560	56	61.6	123.2	23.3	196	4861	232	5754
SL990580	58	63.8	127.6	24.2	203	5419	240	6407
SL990600	60	66.0	132.0	25.0	210	5989	248	7073
SL990620	62	68.2	136.4	26.0	217	6659	256	7856

PART NO.	FERRULE CODE.	A (mm)	B (mm)	S (mm)	L (mm)	WEIGHT Kgs/1000Pcs	L' (mm) GB 6946-93	WEIGHT'(GB) Kgs/1000Pcs
SL990640	64	70.4	140.8	26.7	224	7280	264	8580
SL990660	66	72.6	145.2	27.5	231	7972	272	9387
SL990680	68	74.8	149.6	28.3	238	8707	280	10243
SL990700	70	77.0	154.0	29.0	245	9446	288	11104
SL990730	73	80.0	160.0	31.0	257	11064	300	12916
SL990750	75	83.0	166.0	32.0	263	12115	308	14188
SL990770	77	85.0	170.0	33.0	271	13200	316	15393
SL990800	80	88.0	176.0	34.0	280	14535	328	17027
SL990850	85	94.0	188.0	36.0	298	17467	348	20398
SL990900	90	99.0	198.0	38.0	315	20535	369	24055
SL990950	95	105.0	210.0	40.0	333	24201	390	28344
SL991000	100	110.0	220.0	42.0	350	27992	410	32791
SL991050	105	116.0	232.0	44.0	368	32475	431	38034
SL991100	110	121.0	242.0	46.0	385	37066	451	43420
SL991150	115	126.0	252.0	48.0	403	42175	472	49396
SL991200	120	132.0	264.0	50.0	420	47915	492	56129
SL991250	125	138.0	276.0	52.5	438	54896	513	64296
SL991300	130	143.0	286.0	54.5	455	61365	533	71885
SL991350	135	149.0	298.0	56.5	473	68843	554	80632
SL991400	140	154.0	308.0	59.0	490	77122	574	90342
SL991500	150	165.0	330.0	63.0	525	94474	615	110669

## 无缝铝合金圆管

### Seamless Aluminium Round Sleeves

PART NO.	ITEM NO.	B (mm) OUTER DIA	A (mm) INNER DIA	S (mm) THICKNESS	L (mm) LENGTH	WEIGHT KGS/1000PCS
SL9S0360	#36	95.00	65.00	15.00	152	1.57
SL9S0380	#38	100.00	68.40	15.80	160	1.83
SL9S0400	#40	106.00	72.80	16.60	168	2.19
SL9S0440	#44	116.00	79.60	18.20	185	2.82
SL9S0480	#48	126.00	86.40	19.80	202	3.62
SL9S0520	#52	136.00	93.20	21.40	218	4.68
SL9S0560	#56	147.00	101.00	23.00	235	5.68
SL9S0600	#60	158.00	108.80	24.60	252	7.0
SL9S0620	#62	165.00	113.00	26.00	260	7.9
SL9S0650	#65	176.00	119.20	28.40	273	9.2
SL9S0680	#68	180.00	122.00	29.00	280	10.6
SL9S0700	#70	185.00	125.00	30.00	294	11.6
SL9S0750	#75	198.00	134.00	32.00	315	14.4
SL9S0800	#80	210.00	142.00	34.00	336	17.0
SL9S0850	#85	225.00	153.00	36.00	357	20.5
SL9S0900	#90	240.00	164.00	38.00	378	24.4
SL9S0950	#95	250.00	170.00	40.00	399	28.9
SL9S1000	#100	268.00	184.00	42.00	420	33.9
SL9S1050	#105	277.00	189.00	44.00	441	39.4
SL9S1100	#110	290.00	198.00	46.00	462	45.2
SL9S1150	#115	303.00	207.00	48.00	483	50.5
SL9S1200	#120	317.00	217.00	50.00	504	57.7
SL9S1250	#125	330.00	226.00	52.00	525	65.1
SL9S1300	#130	343.00	235.00	54.00	546	75.1



## 美式椭圆形铝套 Aluminium Oval Sleeves

SAFETYLIFT ALUMINIUM OVAL SLEEVES are extruded from a high quality aluminium alloy, and heat treated for excellent cold forming or swaging qualities. Return eye splice using SAFETY ALUMINIUM SLEEVES will attain 95% of Improved plow wire rope catalog strength when properly swaged.

CAUTION: Return eye slings using oval aluminium sleeves must be properly swaged to attain strength.

PART NO.	SIZE	A (in)	B (in)	C (in)	D (in)	L (in)	WEIGHT Lbs/100Pcs
SL990108	1/8"	5/32	5/16	11/32	1/2	5/8	0.66
SL990316	3/16"	7/32	7/16	7/16	21/32	1	1.65
SL990104	1/4"	19/64	19/32	17/32	27/32	1	2.3
SL990516	5/16"	3/8	3/4	21/32	1 1/32	1 17/84	4.3
SL990308	3/8"	7/16	27/32	3/4	1 5/32	1 3/8	5.3
SL990716	7/16"	1/2	1	29/32	1 13/32	1 23/32	11
SL990102	1/2"	19/32	1 11/64	1 1/32	1 5/8	1 15/16	16.5
SL990916	9/16"	23/32	1 3/8	1 7/32	1 57/64	2 7/32	22
SL990508	5/8"	3/4	1 1/2	1 3/8	2 3/32	2 1/2	32
SL990304	3/4"	53/64	1 11/16	1 1/2	2 3/8	2 7/8	52
SL990708	7/8"	61/64	1 7/8	1 11/16	2 5/8	3	67
SL991000	1"	1 3/32	2 7/32	1 31/32	3 3/32	3 3/4	125
SL991108	1 1/8"	1 9/32	2 9/16	2 5/16	3 19/32	4 9/32	172
SL991104	1 1/4"	1 13/32	2 25/32	2 1/2	3 7/8	4 7/16	214
SL991102	1 1/2"	1 21/32	3 19/64	3 1/8	4 3/4	5 35/64	390

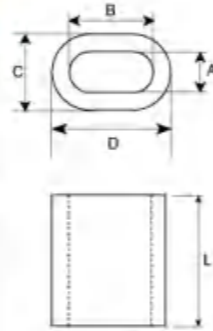

## 美式八字形铝套 Aluminium Hourglass Sleeves

PART NO.	SIZE		A		B		C		D		L		WEIGHT Kgs/1000 Pcs
	in	mm	in	mm	in	mm	in	mm	in	mm	in	mm	
SL980132	1/32	0.79	7/128	1.4	7/64	2.8	1/8	3.1	11/64	4.4	3/8	9.5	0.205
SL980364	3/64	1.19	1/16	1.59	1/8	3.18	9/64	3.6	13/64	5.2	3/8	9.5	0.295
SL980116	1/16	1.58	5/64	1.98	5/32	3.96	11/64	4.4	1/4	6.4	3/8	9.5	0.439
SL980564	5/64	1.98	3/32	2.38	3/16	4.76	13/64	5.2	5/16	7.9	3/8	9.5	0.665
SL980332	3/32	2.38	1/8	3.18	1/4	6.36	9/32	7.1	13/32	10.3	1/2	12.7	1.581
SL980108	1/8	3.18	5/32	3.97	5/16	7.94	11/32	8.7	1/2	12.7	5/8	15.8	2.923
SL980532	5/32	3.97	3/16	4.76	3/8	9.52	3/8	9.53	9/16	14.3	11/16	17.4	3.706
SL980316	3/16	4.76	7/32	5.56	7/16	11.12	7/16	11.11	21/32	16.7	1	25.4	7.393
SL980732	7/32	5.56	1/4	6.35	1/2	12.7	1/2	12.7	3/4	19.0	1-1/16	26.9	10.23
SL980104	1/4	6.35	9/32	7.14	9/16	14.28	17/32	13.5	13/16	20.6	1-1/8	28.5	11.91
SL980932	9/32	7.14	5/16	7.94	5/8	15.88	9/16	14.3	7/8	22.2	1-3/16	30.1	13.72
SL980516	5/16	7.94	3/8	9.53	23/32	19.06	11/16	17.5	1-1/16	27.0	1-1/4	31.7	21.81
SL980308	3/8	9.53	7/16	11.11	27/32	22.22	3/4	19.1	1-3/16	30.2	1-7/16	36.5	28.53
SL980716	7/16	11.11	1/2	12.7	1	25.4	15/16	23.8	1-7/16	36.5	1-11/16	42.8	55.48
SL980102	1/2	12.7	9/16	14.29	1-1/8	28.58	1-1/16	27.0	1-5/8	41.3	2	50.8	84.96
SL980916	9/16	14.29	5/8	15.88	1-1/4	31.76	1-1/8	28.6	1-3/4	44.5	2-1/8	53.9	98.14
SL980508	5/8	15.88	11/16	17.46	1-3/8	34.92	1-1/4	31.8	1-15/16	49.2	2-1/2	63.5	143.4
SL980304	3/4	19.06	13/16	20.64	1-5/8	41.28	1-1/2	38.1	2-5/16	58.7	2-7/8	73.0	240.0
SL980708	7/8	22.23	31/32	24.61	1-15/16	49.22	1-25/32	45.2	2-3/4	69.9	3-3/8	85.5	395.4
SL981000	1	25.4	1-3/32	27.78	2-3/16	55.56	1-31/32	50.0	3-1/16	77.8	3-7/8	98.0	545.3

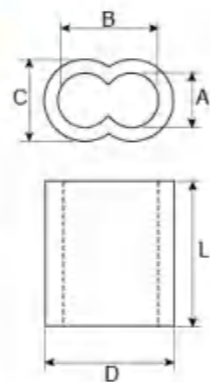

\*The larger sizes of sleeves are available on request.

## 美式圆形铝套 Aluminium Stop Buttons



PART NO.	SIZE	A(mm) Inner Dia.	D(mm) Outer Dia.	L(mm) Length	WEIGHT Kgs/1000Pcs
SL970364	3/64"	1.54	4.40	4.16	0.236
SL970116	1/16"	1.92	6.35	4.16	0.278
SL970564	5/64"	2.38	6.35	4.16	0.282
SL970332	3/32"	2.90	8.72	7.95	1.05
SL970108	1/8"	3.86	8.72	7.95	0.949
SL970532	5/32"	4.70	11.11	8.73	1.76
SL970316	3/16"	5.54	11.11	8.73	1.69
SL970732	7/32"	6.35	11.11	8.73	1.50
SL970104	1/4"	7.20	17.46	17.46	9.07
SL970516	5/16"	9.53	17.46	17.46	7.46
SL970308	3/8"	11.13	17.46	17.46	6.58
SL970102	1/2"	14.28	26.98	26.98	30.32
SL970916	9/16"	15.88	28.60	31.75	38.52
SL970508	5/8"	17.46	31.75	31.75	47.88

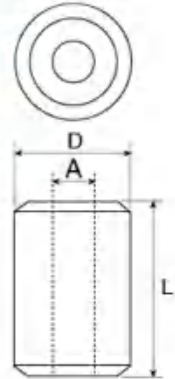

## 日式外椭圆内八字形铝套 Aluminium Ferrules JIS Type



PART NO.	FERRULE CODE.	A (mm)	B (mm)	C (mm)	D (mm)	L (mm)	WEIGHT Kgs/1000Pcs
SL960060	6	7.00	13.8	3.20	3.80	24	9.864
SL960070	7	8.20	16.2	3.60	4.25	26	13.97
SL960080	8	9.40	18.6	4.00	4.70	32	21.78
SL960090	9	10.20	20.7	4.30	5.52	36	29.45
SL960100	10	11.60	23.0	4.50	5.50	40	37.43
SL960120	12	13.62	27.6	5.30	6.92	48	63.81
SL960140	14	15.89	32.2	5.53	7.42	56	89.42
SL960160	16	18.16	36.8	6.32	8.48	64	133.5
SL960180	18	20.43	41.4	7.11	9.54	72	190.0
SL960200	20	23.10	46.0	7.70	9.20	80	248.5
SL960220	22	25.40	50.6	8.30	10.0	88	323.5
SL960240	24	27.80	55.3	8.90	10.9	96	413.7
SL960260	26	29.90	59.8	10.7	12.9	104	590.5
SL960280	28	32.20	64.4	11.3	13.6	112	720.7
SL960300	30	34.50	69.0	11.8	14.3	120	861.4
SL960320	32	36.80	73.6	12.5	15.2	128	1038
SL960340	34	39.10	78.2	13.3	16.2	136	1247
SL960360	36	41.40	82.8	14.1	17.3	142	1464
SL960380	38	43.70	87.4	14.9	18.4	150	1727

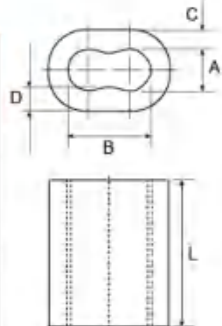

## 德式椭圆形带孔铝套 Aluminium Ferrules Form C

PART NO.	FERRULE CODE.	L1 (mm)	L2 (mm)	PART NO.	FERRULE CODE.	L1 (mm)	L2 (mm)
SL950060	6	27.9	21	SL950300	30	139.5	105
SL950065	6.5	30.2	23	SL950320	32	148.8	112
SL950070	7	32.6	25	SL950340	34	158.1	119
SL950080	8	37.2	28	SL950360	36	167.4	126
SL950090	9	41.9	32	SL950380	38	176.7	133
SL950100	10	46.5	35	SL950400	40	186.0	140
SL950110	11	51.0	39	SL950420	42	195.3	147
SL950120	12	55.8	42	SL950440	44	204.6	154
SL950130	13	60.5	46	SL950460	46	213.9	161
SL950140	14	65.1	49	SL950480	48	223.2	168
SL950160	16	74.4	56	SL950500	50	232.5	175
SL950180	18	83.7	63	SL950520	52	241.8	182
SL950200	20	93.0	70	SL950540	54	251.1	189
SL950220	22	102.3	77	SL950560	56	260.4	196
SL950240	24	111.6	84	SL950580	58	269.7	203
SL950260	26	120.9	91	SL950600	60	279.0	210
SL950280	28	130.2	98				

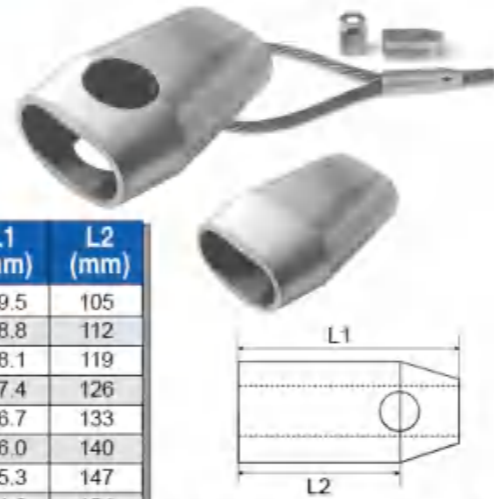

### Without inspection hole

The inspection hole guarantees control of the correct inserted length of wire rope before and after swaging. These types of sleeves have to be swaged with the conical type C swaging dies.

## 德式椭圆形铜套 Copper Ferrules

PART NO.	FERRULE CODE.	A (mm)	B (mm)	S (mm)	L (mm)	WEIGHT kgs/1000pcs
SL890010	1	1.2	2.4	0.65	5	0.239
SL890015	1.5	1.7	3.4	0.75	6	0.447
SL890020	2	2.2	4.4	0.85	7	0.745
SL890025	2.5	2.7	5.4	1.05	9	1.453
SL890030	3	3.3	6.6	1.25	11	2.571
SL890035	3.5	3.8	7.6	1.50	13	4.232
SL890040	4	4.4	8.8	1.70	14	5.957
SL890045	4.5	4.9	9.8	1.90	16	8.479
SL890050	5	5.5	11.0	2.10	18	11.80
SL890060	6	6.6	13.2	2.50	21	19.64
SL890065	6.5	7.2	14.4	2.70	23	25.29
SL890070	7	7.8	15.6	2.90	25	31.93
SL890080	8	8.8	17.6	3.30	28	45.99
SL890090	9	9.9	19.8	3.70	32	66.26
SL890100	10	10.9	21.8	4.10	35	88.52
SL890110	11	12.1	24.2	4.50	39	119.9
SL890120	12	13.2	26.4	4.90	42	153.4
SL890130	13	14.2	28.4	5.40	46	200.0
SL890140	14	15.3	30.6	5.80	49	246.4
SL890160	16	17.5	35.0	6.70	56	372.8
SL890180	18	19.6	39.2	7.60	63	534.2
SL890200	20	21.7	43.4	8.40	70	726.0
SL890220	22	24.3	48.6	9.20	77	975.4
SL890240	24	26.4	52.8	10.0	84	1257

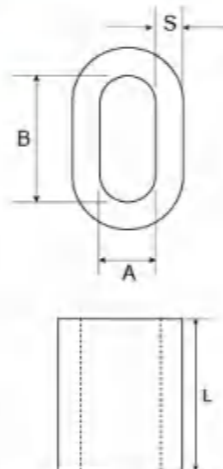

## 美式八字形铜套 Copper Hourglass Sleeves

SAFETYLIFT extruded copper hourglass sleeves and stop buttons have efficient cold forming properties, and are ideal for non-rusting permanent splices. These sleeves and buttons are 99% pure copper, and the mass of copper provides excellent holding strength. Return eye splice using SAFETYLIFT copper hourglass sleeves will attain 95% of Improved Plow wire rope catalog strength when properly swaged. CAUTION: Return eye slings using copper hourglass sleeves must be properly swaged to attain strength.

PART NO.	SIZE	A (in)	B (in)	C (in)	D (in)	L (in)	WEIGHT Kgs/1000Pcs
SL880132	1/32"	3/64	3/32	3/32	9/64	1/4	0.3
SL880364	3/64"	1/16	1/8	9/64	13/64	3/8	1.0
SL880116	1/16"	3/32	11/64	11/16	1/4	25/64	1.4
SL880332	3/32"	7/64	1/4	15/64	3/8	29/64	4.4
SL880108	1/8"	5/32	21/64	21/64	1/2	9/16	8.0
SL880532	5/32"	3/16	27/64	3/8	19/32	5/8	10.9
SL880316	3/16"	7/32	7/16	7/16	43/64	7/8	20.3
SL880732	7/32"	1/4	33/64	15/32	23/32	7/8	22.2
SL880104	1/4"	9/32	19/32	17/32	27/32	1 1/8	38
SL880516	5/16"	3/8	23/32	21/32	1 1/64	1 1/8	60
SL880308	3/8"	7/16	13/16	23/32	1 1/8	1 1/2	80
SL880716	7/16"	1/2	1	13/16	1 21/64	1 11/16	125
SL880102	1/2"	19/32	17/64	31/32	1 15/32	1 7/8	180
SL880508	5/8"	47/64	1 7/16	1 13/64	1 29/32	2 23/64	363

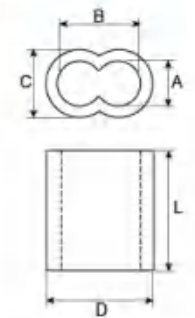

## 美式圆形铜套 Copper Button Stops

PART NO.	SIZE	A (in)	D (in)	L (in)	WEIGHT Kgs/1000Pcs
SL870364	3/64"	1/16	11/64	7/32	0.67
SL870116	1/16"	5/64	13/64	7/32	0.96
SL870332	3/32"	7/64	21/64	21/64	3.9
SL870108	1/8"	5/32	21/64	21/64	3.3
SL870532	5/32"	3/16	27/64	21/64	6.5
SL870316	3/16"	7/32	27/64	21/64	6.2
SL870732	7/32"	1/4	27/64	5/8	6.0
SL870104	1/4"	9/32	21/32	11/16	32
SL870516	5/16"	3/8	21/32	11/16	29

Zinc Plated, Nickle Plated & Chrome Plated are available on request

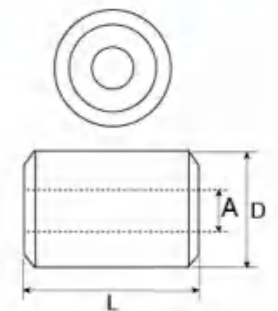

Zinc Plated, Nickle Plated & Chrome Plated are available on request

## 法烈米氏式钢套 Flemish Eye Steel Swaging Sleeves(S-505)

Our modern in-house forging, heat treatment, sand blasting, auto-marking facilities assures the consistent quality of Flemish eye steel sleeves from 1/4" to 6". (galvanized and black)

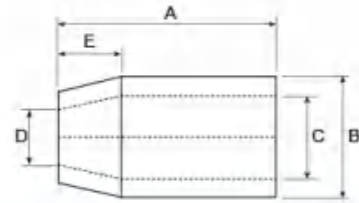

PART NO.	FOR WIRE ROPE SIZE (inch)	DIMENSION (inch)					MAX.AFTER SWAGE DIMENSIONS (inch)	WEIGHT Kgs/ 100Pcs
		A	B	D	E	C		
SL700104	1/4"	1	0.66	0.31	0.28	0.47	0.57	2.27
SL700516	5/16"	1.5	0.91	0.38	0.44	0.62	0.75	6.36
SL700308	3/8"	1.5	0.91	0.47	0.39	0.66	0.75	6.36
SL700716	7/16"	2	1.22	0.53	0.65	0.85	1.01	15
SL700102	1/2"	2	1.22	0.63	0.56	0.91	1.01	13
SL700916	9/16"	2.75	1.47	0.7	0.63	1.03	1.24	29
SL700508	5/8"	2.75	1.47	0.75	0.63	1.09	1.24	26
SL700304	3/4"	3.19	1.72	0.91	0.84	1.28	1.46	40
SL700708	7/8"	3.56	2.03	1.03	1	1.53	1.68	60
SL701000	1"	4	2.28	1.16	1.13	1.72	1.93	89
SL701108	1-1/8"	4.8	2.5	1.28	1.25	1.94	2.13	118
SL701104	1-1/4"	5.19	2.78	1.44	1.41	2.16	2.32	161
SL701308	1-3/8"	5.81	3	1.56	1.56	2.38	2.52	192
SL701102	1-1/2"	6.25	3.25	1.69	1.69	2.63	2.71	227
SL701304	1-3/4"	7.25	3.84	1.94	1.97	3.13	3.1	366
SL702000	2"	8.5	4.38	2.25	2.25	3.63	3.56	514
SL702104	2-1/4"	9.56	5.03	2.5	2.53	4.03	4.12	879
SL702102	2-1/2"	10.5	5.5	2.75	2.81	4.50	4.5	1068
SL702304	2-3/4"	11.5	5.75	3	3.09	4.75	4.7	1271
SL703000	3"	12	6	3.25	3.38	5	4.96	1335
SL703104	3-1/4"	13	6.5	3.86	3.54	5.43	5.37	1650
SL703102	3-1/2"	14	7	3.88	3.94	5.84	5.77	2106
SL703304	3-3/4"	15	7.5	4.06	4.25	6.31	6.23	2497
SL704000	4"	16	8.13	4.38	4.50	6.81	6.69	3087
SL704102	4-1/2"	18	9.23	4.88	5.06	7.66	7.45	4540
SL705000	5"	20	10.52	5.45	5.63	8.73	8.65	6850
SL705102	5-1/2"	22	11.38	6.03	6.22	9.37	9.53	9200
SL706000	6"	24	12.48	6.5	6.75	10.2	10.40	12400

⚠ Recommended to be used with 6x19, 6x25, 6x29, 6x37 IPS or XIP(EIP), FC or IWRC wire rope. If using with any other type of construction or grade of wire rope, it is recommended to make the breaking load test of the swaged termination to prove the adequacy of the assembly to be manufactured.

## 椭圆形钢套 Steel Oval Sleeves

Specially processed low carbon steel

Note: Steel Oval Sleeves are recommended for use with 6x19 or 6x37, IPS OR XIP(EIP), RRL, FC or IWRC wire rope



PART NO.	ROPE SIZE (inch)	L(in)	B(in)	C(in)	D(in)	MAX.AFTER SWAGE DIA. (inch)	WEIGHT Lbs/ 100Pcs
SL790516	5/16	1.25	1.08	0.81	0.19	0.77	17
SL790308	3/8	1.25	1.12	0.81	0.14	0.77	13
SL790716	7/16	1.63	1.41	1.02	0.19	1.03	31
SL790102	1/2	1.63	1.44	1.02	0.16	1.03	27
SL790916	9/16	2.25	1.72	1.23	0.23	1.29	63
SL790508	5/8	2.25	1.84	1.28	0.20	1.29	54
SL790304	3/4	2.63	2.16	1.52	0.23	1.55	90
SL790708	7/8	2.88	2.50	1.75	0.27	1.80	126
SL791000	1	3.06	2.84	2.00	0.33	2.05	187
SL791104	1-1/4	4.06	3.50	2.50	0.38	2.56	384

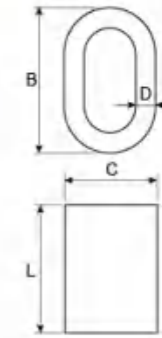

## 圆形钢套 Steel Stop Buttons

Specially processed low carbon steel



PART NO.	ROPE SIZE (inch)	A(in)	D(in)	L(in)	MAX.AFTER SWAGE DIA. (inch)	WEIGHT Lbs/ 100Pcs
SL770108	1/8	0.14	0.44	0.50	0.40	2
SL770316	3/16	0.20	0.56	0.70	0.52	4
SL770104	1/4	0.30	0.63	1.06	0.58	8
SL770516	5/16	0.36	0.88	1.13	0.77	16
SL770308	3/8	0.42	0.88	1.48	0.77	15
SL770716	7/16	0.48	1.13	1.63	1.03	30
SL770102	1/2	0.55	1.31	1.89	1.16	50
SL770916	9/16	0.61	1.44	2.02	1.29	70
SL770508	5/8	0.67	1.56	2.42	1.42	100
SL770304	3/4	0.79	1.69	2.73	1.55	131
SL770708	7/8	0.94	2.00	3.27	1.80	220
SL771000	1	1.06	2.25	3.67	2.05	310
SL771108	1-1/8	1.19	2.56	4.05	2.30	450
SL771104	1-1/4	1.33	2.81	4.58	2.56	650

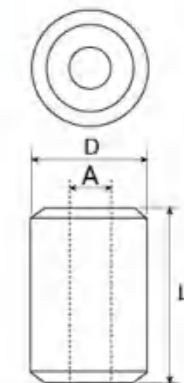

⚠ Recommended to be used with 6x19, 6x25, 6x29, 6x37 IPS or XIP(EIP), FC or IWRC wire rope. If using with any other type of construction or grade of wire rope, it is recommended to make the breaking load test of the swaged termination to prove the adequacy of the assembly to be manufactured.



## 不锈钢椭圆钢套 Stainless Steel Ferrules

SAFETYLIFT stainless steel ferrules are made from stainless steel. Both SS316 and SS304 are available. The available sizes are from 1-30. Special sizes could be custom-made. They have common uses in marine applications and they are widely used in architectural designs e.g. balustrades and fencing. These ferrules are normally used on stainless steel wire ropes to achieve the best possible resistance against corrosion.

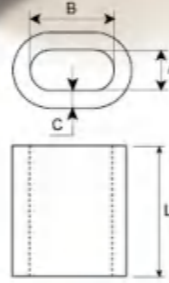
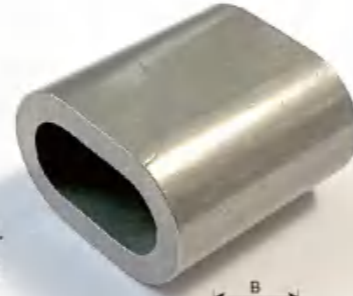

Part No.	SIZE(mm)	A(MM)	B(MM)	C(MM)	L(MM)	WEIGHT kgs/1000Pcs
SL690010	1	1.2	2.4	1.0	5.0	0.372
SL690015	1.5	1.65	3.55	1.0	6.0	0.581
SL690020	2	2.4	4.8	1.0	7.0	0.865
SL690025	2.5	2.78	5.48	0.91	9.0	1.110
SL690030	3	3.7	7.3	1.0	9.6	1.683
SL690035	3.5	3.84	7.64	1.63	11.2	3.611
SL690040	4	4.3	8.6	1.5	12.8	4.110
SL690045	4.5	4.9	9.8	2.0	14.4	7.233
SL690050	5	6.1	12.2	2.0	16.0	9.614
SL690060	6	6.7	13.4	2.5	19.2	16.20
SL690070	7	7.9	15.9	2.5	22.4	21.75
SL690080	8	9.1	18.2	3.2	25.6	37.16
SL690090	9	10.4	20.8	3.5	28.8	51.86
SL690100	10	11.5	23.0	3.91	32.0	71.30
SL690110	11	12.2	24.4	4.0	35.2	84.60
SL690120	12	13.2	26.4	4.6	38.4	116.04
SL690130	13	14.3	28.6	5.0	41.6	148.11
SL690140	14	15.5	31.0	5.3	44.8	182.55
SL690160	16	17.7	35.4	6.1	51.2	274.56
SL690180	18	19.9	39.8	6.9	57.6	393.3
SL690200	20	22.2	44.5	7.6	64.0	536.5
SL690220	22	24.4	48.9	8.4	70.4	717.5
SL690240	24	26.5	53.0	9.1	76.8	919.3
SL690260	26	28.7	57.4	10.0	83.2	1188.3
SL690280	28	30.8	61.6	10.8	89.6	1484.9
SL690300	30	33.0	66.0	11.5	96.0	1813.1

## 座式多功能压接钳 Multi-function Swaging Tool Bench Type

Part No.	Size	N.W. kgs
MMBS2400	24"	5.69



Head drop-forged with alloy steel, body special heat treatment  
Cutting edges induction quenched  
Joint arms drop-forged, base precision casted, base measures 3 x 6" (76 x 152mm)  
Used for cutting 6mm wire rope and press 1/16" - 3/16" oval sleeve (Aluminum)  
Operating by one hand for easy cutting

## 多功能压接钳 Multi-function Swaging Tool

Part No.	Size	N.W. kgs
MMHS1400	14"	1.05
MMHS2400	24"	2.5

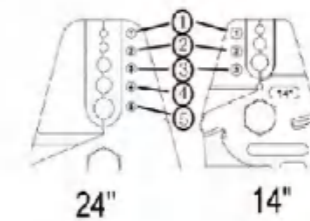

Blades drop-forged with high quality alloy steel, Body heat treatment  
Cutting edges induction quenched,  
Used for cutting 6mm wire rope and press 1/16" - 3/16" oval sleeve (Aluminum)  
Industry class quality

- \* Forged Steel Sockets thru 1 1/2" , cast alloy steel 1-5/8" thru 4"
  - \* Spelter socket terminations have an efficiency rating of 100%,based on the catalog strength of wire rope.
- Ratings are based on recommended use with 6x7, 6x19 or 6x37, IPS OR XIP, XXIP(EIP), RRL, FC, OR IWRC wire rope.

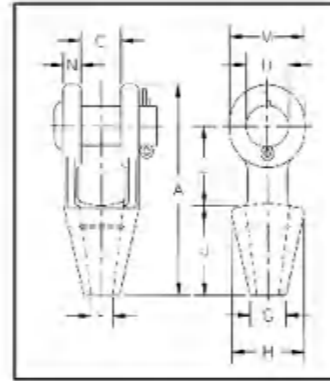

Note:Above drawing illustrates one groove used on sockets 1/4" thru 3/4" Size 7/8" thru 1 1/2" use 2 grooves, Sizes 1 5/8" and larger use 3 grooves.

## 开式锥形承接权 Grooved Open Spelter Sockets

Open Grooved Sockets meet the performance requirements of Federal Specification RR-S-550D, Type A, except for those provisions required of the contractor.

- \* Forged Steel Sockets thru 1 1/2" , cast alloy steel 1-5/8" thru 4"
  - \* Spelter socket terminations have an efficiency rating of 100%,based on the catalog strength of wire rope.
- Ratings are based on recommended use with 6x7, 6x19 or 6x37, IPS OR XIP, XXIP(EIP), RRL, FC, OR IWRC wire rope.

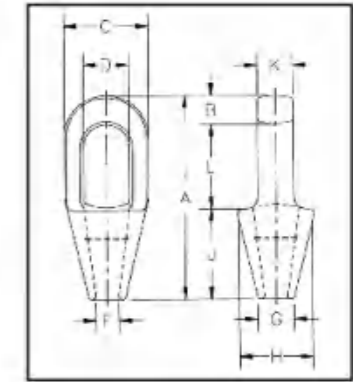

Note:Above drawing illustrates one groove used on sockets 1/4" thru 3/4" Size 7/8" thru 1 1/2" use 2 grooves, Sizes 1 5/8" and larger use 3 grooves.

## 闭式锥形承接环 Grooved Closed Spelter Sockets

Closed Grooved Sockets meet the performance requirements of Federal Specification RR-S-550D, Type B, except for those provisions required of the contractor.

PART NO.	ROPE SIZE (inch)	WEIGHT Lbs/ Pcs	DIMENSION (in.)									
			A	C	D	F	G	H	J	L	M	N
SL720104	1/4	1.10	4.56	0.75	0.69	0.38	0.69	1.56	2.25	1.56	1.31	0.31
SL720516	5/16-3/8	1.30	4.84	0.81	0.81	0.50	0.81	1.69	2.25	1.75	1.50	0.44
SL720716	7/16-1/2	2.25	5.56	1.00	1.00	0.56	0.94	1.88	2.50	2.00	1.88	0.50
SL720916	9/16-5/8	3.60	6.75	1.25	1.19	0.69	1.13	2.25	3.00	2.50	2.25	0.56
SL720304	3/4	5.83	7.94	1.50	1.38	0.81	1.25	2.62	3.50	3.00	2.62	0.62
SL720708	7/8	9.65	9.25	1.75	1.63	0.94	1.50	3.25	4.00	3.50	3.13	0.80
SL721000	1	15.50	10.56	2.00	2.00	1.13	1.75	3.75	4.50	4.00	3.75	0.88
SL721108	1 1/8	21.50	11.81	2.25	2.25	1.25	2.00	4.12	5.00	4.62	4.12	1.00
SL721104	1 1/4-1 3/8	31.00	13.19	2.50	2.50	1.50	2.25	4.75	5.50	5.00	4.75	1.13
SL721102	1 1/2	47.25	15.12	3.00	2.75	1.63	2.75	5.25	6.00	6.00	5.38	1.19
SL721508	1 5/8	55.00	16.25	3.00	3.00	1.75	3.00	5.50	6.50	6.50	5.75	1.31
SL721304	1 3/4-1 7/8	82.00	18.25	3.50	3.50	2.00	3.13	6.38	7.50	7.00	6.50	1.56
SL722000	2-2 1/8	129.00	21.50	4.00	3.75	2.25	3.75	7.38	8.50	9.00	7.00	1.81
SL722104	2 1/4-2 3/8	167.00	23.50	4.50	4.25	2.50	4.00	8.25	9.00	10.00	7.75	2.13
SL722102	2 1/2-2 5/8	252.00	25.50	5.00	4.75	2.88	4.50	9.25	9.75	10.75	8.50	2.38
SL722304	2 3/4-2 7/8	315.00	27.25	5.25	5.00	3.12	4.88	10.50	11.00	11.00	9.00	2.88
SL723000	3-3 1/8	380.00	29.00	5.75	5.25	3.38	5.25	11.12	12.00	11.25	9.50	3.00
SL723104	3 1/4-3 3/8	434.00	30.88	6.25	5.50	3.62	5.75	11.88	13.00	11.75	10.00	3.12
SL723102	3 1/2-3 5/8	563.00	33.25	6.75	6.00	3.88	6.50	12.38	14.00	12.50	10.75	3.25
SL723304	3 3/4-4	783.00	36.25	7.50	7.00	4.25	7.25	13.62	15.00	13.50	12.50	3.50

PART NO.	ROPE SIZE (inch)	WEIGHT Lbs/ Pcs	DIMENSION (in.)									
			A	B	C	D	F	G	H	J	K	L
SL710104	1/4	0.50	4.50	0.50	1.50	0.88	0.38	0.69	1.56	2.25	0.50	1.75
SL710516	5/16-3/8	0.75	4.88	0.62	1.69	0.97	0.50	0.81	1.69	2.25	0.69	2.00
SL710716	7/16-1/2	1.50	5.44	0.69	2.00	1.16	0.56	0.94	1.88	2.50	0.88	2.25
SL710916	9/16-5/8	2.50	6.31	0.81	2.63	1.41	0.69	1.12	2.38	3.00	1.00	2.50
SL710304	3/4	4.25	7.56	1.06	3.00	1.66	0.81	1.25	2.75	3.56	1.25	3.00
SL710708	7/8	7.25	8.75	1.25	3.63	1.88	0.94	1.50	3.25	4.00	1.50	3.50
SL711000	1	10.50	9.88	1.38	4.13	2.30	1.13	1.75	3.75	4.44	1.75	4.00
SL711108	1 1/8	14.25	11.00	1.50	4.50	2.56	1.25	2.00	4.13	5.00	2.00	4.50
SL711104	1 1/4-1 3/8	19.75	12.12	1.63	5.30	2.81	1.50	2.25	4.75	5.50	2.25	5.00
SL711102	1 1/2	29.20	13.94	1.94	5.33	3.19	1.63	2.75	5.25	6.00	2.50	6.00
SL711508	1 5/8	36.00	15.13	2.13	5.75	3.25	1.75	3.00	5.50	6.50	2.75	6.50
SL711304	1 3/4-1 7/8	57.25	17.25	2.19	6.75	3.75	2.00	3.13	6.38	7.50	3.00	7.56
SL712000	2-2 1/8	79.00	19.50	2.44	7.63	4.38	2.25	3.75	7.38	8.50	3.25	8.56
SL712104	2 1/4-2 3/8	105.00	21.13	2.63	8.50	5.00	2.50	4.00	8.25	9.00	3.63	9.50
SL712102	2 1/2-2 5/8	140.00	23.50	3.12	9.50	5.50	2.88	4.50	9.25	9.75	4.00	10.62
SL712304	2 3/4-2 7/8	220.00	25.38	3.12	10.75	6.25	3.12	4.88	10.19	11.00	4.88	11.25
SL713000	3-3 1/8	276.00	27.00	3.25	11.50	6.75	3.38	5.25	11.50	12.00	5.25	11.75
SL713104	3 1/4-3 3/8	313.00	29.25	4.00	12.25	7.25	3.62	5.75	12.25	13.00	5.75	12.25
SL713102	3 1/2-3 5/8	400.00	31.00	4.00	13.00	7.75	3.88	6.50	13.00	14.00	6.25	13.00
SL713304	3 3/4-4	542.00	33.25	4.25	14.25	8.50	4.25	7.25	14.25	15.00	7.00	14.00

## 钢丝绳端头结构方式 Wire Rope End Terminations



Swaged round sleeve

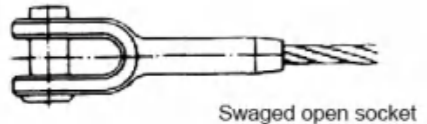

Swaged open socket

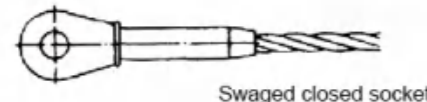

Swaged closed socket

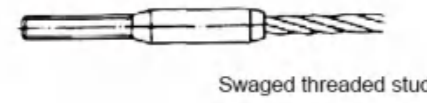

Swaged threaded stud

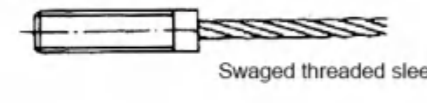

Swaged threaded sleeve



Wedge type socket



Wire rope grip

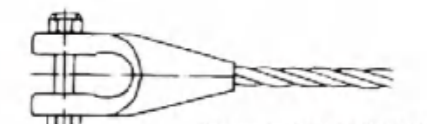

Open socket, socketed



Hand spliced eye



Spliced thimble



Flemish eye splice

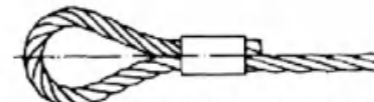

Aluminum swaged eye

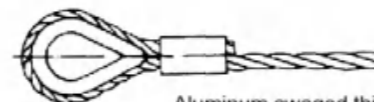

Aluminum swaged thimble

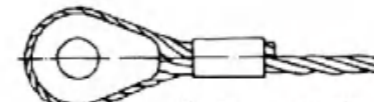

Aluminum swaged solid thimble

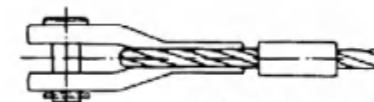

Aluminum swaged open socket

## 吊索类型 Types of Sling

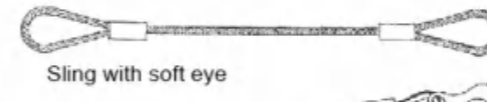

Sling with soft eye

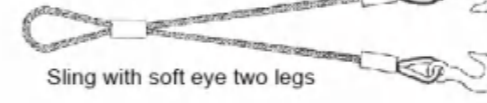

Sling with soft eye two legs

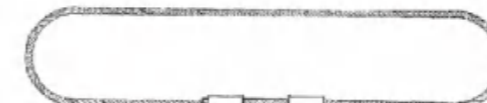

Sling with round

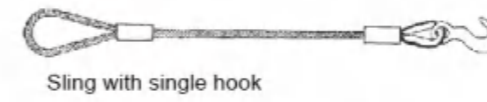

Sling with single hook



Sling for crane

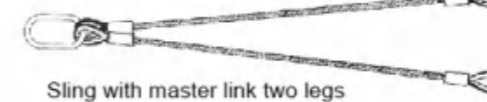

Sling with master link two legs



Sling with master link four legs



Containers sling for sea oil

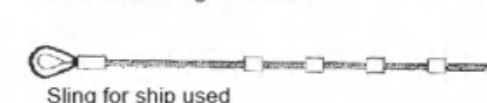

Sling for ship used

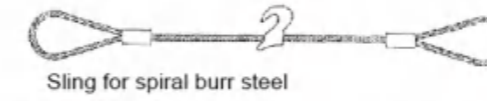

Sling for spiral burr steel

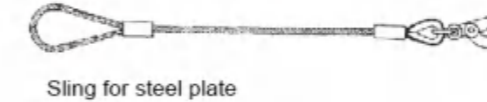

Sling for steel plate

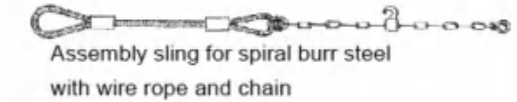

Assembly sling for spiral burr steel with wire rope and chain

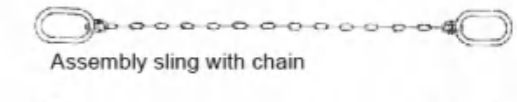

Assembly sling with chain

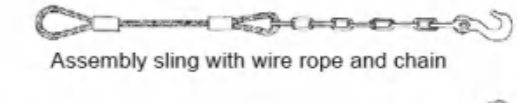

Assembly sling with wire rope and chain

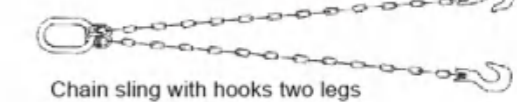

Chain sling with hooks two legs

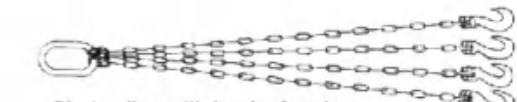

Chain sling with hooks four legs

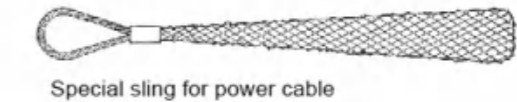

Special sling for power cable

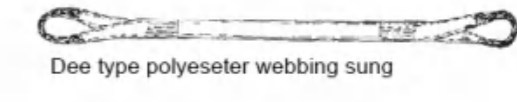

Dee type polyester webbing sling

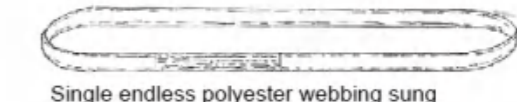

Single endless polyester webbing sling

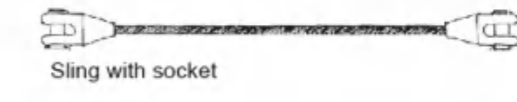

Sling with socket

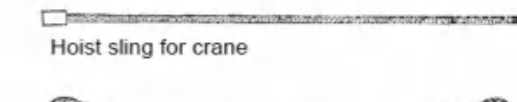

Hoist sling for crane

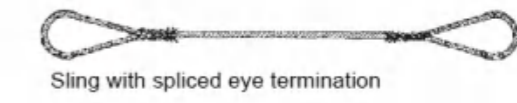

Sling with spliced eye termination

## WS01压接软环索具 WS01 Swaged Soft Eye Slings

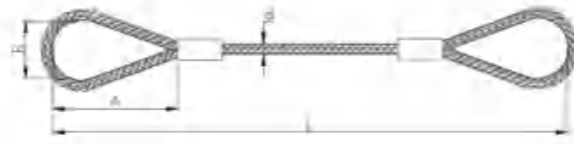

Part No.	Rope dia. d (mm)	Soft loop dimensions (mm)		M.B.L. (t)	Working load limit (t)	
		A	B		n=5	n=6
WS010050	5	130	65	1.25	0.25	0.20
WS010060	6	150	75	1.80	0.36	0.30
WS010070	7	150	75	2.46	0.50	0.40
WS010080	8	200	100	3.21	0.60	0.50
WS010090	9	200	100	4.07	0.80	0.70
WS010100	10	200	100	5.03	1.00	0.80
WS010110	11	230	115	6.08	1.20	1.00
WS010120	12	230	115	7.23	1.50	1.20
WS010130	13	230	115	8.49	1.70	1.40
WS010140	14	250	125	9.85	2.00	1.60
WS010160	16	300	150	12.85	2.60	2.10
WS010180	18	300	150	16.32	3.30	2.70
WS010200	20	350	175	20.09	4.00	3.40
WS010220	22	350	175	24.27	4.90	4.10
WS010240	24	450	225	28.96	5.80	4.80
WS010260	26	450	225	33.96	6.80	5.70
WS010280	28	500	250	39.36	7.90	6.60
WS010300	30	500	250	45.17	9.00	7.50
WS010320	32	550	275	51.39	10.30	8.60
WS010340	34	600	300	58.12	11.60	9.70
WS010360	36	600	300	65.06	13.00	10.80
WS010380	38	600	300	72.50	14.50	12.10
WS010400	40	700	350	80.35	16.10	13.40
WS010420	42	800	400	88.61	17.70	14.80
WS010440	44	800	400	97.28	19.50	16.20
WS010460	46	900	450	106.05	21.20	17.70
WS010480	48	900	450	116.25	23.30	19.40
WS010500	50	1000	500	125.43	25.10	21.00
WS010520	52	1000	500	135.62	27.10	22.70

Note:

1. Steel wire ropes with diameters from Ø5 to Ø60 are 6×37+FC-1670N/mm<sup>2</sup> type complying to the GB/T20118 standard, while the ones with diameters from Ø62 to Ø110 are 6×61+FC-1670N/mm<sup>2</sup> type complying to the GB/T20067 standard.
2. Values "A" or "B" can be customized. Otherwise, the values in the table apply.
3. "L" value meets client requirements; n=5 and n=6 are safety factors, determined by users.

## WS02 插编软环索具 WS02 Spliced Soft Eye Slings



Part No.	Rope dia. d (mm)	Soft loop dimensions (mm)		M.B.L. (t)	Working load limit (t)	
		A	B		n=5	n=6
WS020050	5	130	65	1.25	0.24	0.20
WS020060	6	150	75	1.80	0.34	0.28
WS020070	7	150	75	2.46	0.48	0.38
WS020080	8	200	100	3.21	0.60	0.50
WS020090	9	200	100	4.07	0.72	0.60
WS020100	10	200	100	5.03	0.90	0.75
WS020110	11	230	115	6.08	1.10	0.90
WS020120	12	230	115	7.23	1.30	1.10
WS020130	13	230	115	8.49	1.50	1.30
WS020140	14	250	125	9.85	1.80	1.50
WS020160	16	300	150	12.85	2.30	1.90
WS020180	18	300	150	16.32	2.90	2.40
WS020200	20	350	175	20.09	3.60	3.00
WS020220	22	350	175	24.27	3.90	3.20
WS020240	24	450	225	28.96	4.60	3.90
WS020260	26	450	225	33.96	5.40	4.50
WS020280	28	500	250	39.36	6.30	5.20
WS020300	30	500	250	45.17	7.20	6.00
WS020320	32	550	275	51.39	7.70	6.40
WS020340	34	600	300	58.12	8.70	7.30
WS020360	36	600	300	65.06	9.80	8.10
WS020380	38	600	300	72.50	10.90	9.10
WS020400	40	700	350	80.35	12.10	10.00
WS020420	42	800	400	88.61	12.40	10.30
WS020440	44	800	400	97.28	13.60	11.30
WS020460	46	900	450	106.05	14.80	12.40
WS020480	48	900	450	116.25	16.30	13.60
WS020500	50	1000	500	125.43	17.60	14.60
WS020520	52	1000	500	135.62	19.00	15.80

Note:

1. Steel wire ropes with diameters from Ø5 to Ø60 are 6×37+FC-1670N/mm<sup>2</sup> type complying to the GB/T20118 standard, while the ones with diameters from Ø62 to Ø110 are 6×61+FC-1670N/mm<sup>2</sup> type complying to the GB/T20067 standard.
2. Values "A" or "B" can be customized. Otherwise, the values in the table apply.
3. "L" value meets client requirements; n=5 and n=6 are safety factors, determined by users.

## WS03 法烈米氏插编吊索具

### WS03 6x37+IWRC-1770Mpa

- The wire rope slings pressed with steel sleeves are manufactured according to the EN13414 standard.
- Steel wire rope with diameters from 5mm-130mm can be pressed with steel sleeves, and the Minimum Breaking Load is 5 times of Working Load Limited.
- All the products can pass the 2 times safety tensile test or breaking load test. Certificate of Quality and Certificate of Tensile Test can be offered.
- Wire ropes with different structures have different working load. And working load can be figured out according to the wire rope structure required.

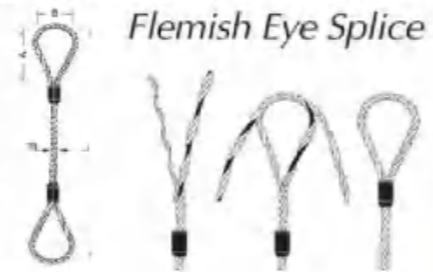

Flemish Eye Splice

Part No.	Rope Dia (mm)	Working Load Limited(Ton)						Eye Size (mm)	
		Vertical	Choker	Basket Hitches			A	B	
WS030100	10	1.2	0.9	2.4	2.0	1.7	1.2	200	100
WS030120	12	1.8	1.4	3.6	3.1	2.5	1.8	240	120
WS030140	14	2.3	1.8	4.6	4.0	3.2	2.3	280	140
WS030160	16	3.0	2.0	6.0	5.0	4.0	3.0	320	160
WS030180	18	4.0	3.0	8.0	7.0	6.0	4.0	360	180
WS030200	20	5.0	4.0	10.0	8.0	7.0	5.0	400	200
WS030220	22	6.0	5.0	12.0	10.0	8.0	6.0	440	220
WS030240	24	7.0	5.0	14.0	12.0	10.0	7.0	480	240
WS030260	26	8.0	6.0	16.0	14.0	11.0	8.0	520	260
WS030280	28	9.0	7.0	18.0	16.0	13.0	9.0	560	280
WS030300	30	11.0	9.0	22.0	19.0	15.0	11.0	600	300
WS030320	32	12.0	10.0	24.0	21.0	17.0	12.0	640	320
WS030340	34	14.0	11.0	28.0	24.0	19.0	14.0	680	340
WS030360	36	15.0	12.0	30.0	27.0	22.0	15.0	720	360
WS030380	38	17.0	14.0	34.0	30.0	24.0	17.0	760	380
WS030400	40	19.0	15.0	38.0	33.0	27.0	19.0	800	400
WS030420	42	21.0	17.0	42.0	37.0	30.0	21.0	840	420
WS030450	45	24.0	19.0	48.0	42.0	34.0	24.0	900	450
WS030500	50	30.0	24.0	60.0	52.0	42.0	30.0	1000	500
WS030520	52	32.0	26.0	64.0	56.0	46.0	32.0	1040	520
WS030560	56	37.0	30.0	74.0	65.0	53.0	37.0	1120	560
WS030600	60	43.0	34.0	86.0	75.0	61.0	43.0	1200	600
WS030650	65	50.0	40.0	100.0	87.0	71.0	50.0	1300	650
WS030700	70	58.0	47.0	116.0	101.0	82.0	58.0	1400	700
WS030750	75	67.0	53.0	134.0	116.0	95.0	67.0	1500	750
WS030800	80	76.0	61.0	152.0	132.0	108.0	76.0	1600	800
WS030850	85	86.0	69.0	172.0	149.0	122.0	86.0	1700	850
WS030900	90	96.0	77.0	192.0	167.0	137.0	96.0	1800	900
WS030950	95	107.0	86.0	214.0	186.0	152.0	107.0	1900	950
WS031000	100	119.0	95.0	238.0	207.0	169.0	119.0	2000	1000
WS031020	102	120.0	96.0	240.0	208.0	170.0	120.0	2040	1020
WS031050	105	123.0	99.0	246.0	214.0	175.0	123.0	2100	1050

\* WLL=MBL X 0.9 (Pressing Efficiency of Aluminum Ferrules)/5 (Safety Factor)

## WS04 预埋绳圈

### WS04 Cast in Lift Anchor



Part No.	Ø (mm)	Load(ton)	Height(mm)	Width(mm)
WS040060	6	0.8	200	50
WS040080	8	1.6	235	70
WS040100	10	2.5	280	80
WS040140	14	5.2	385	180
WS040160	16	6.3	385	180
WS040200	20	10	470	200
WS040220	22	12.5	510	200
WS040240	24	16	560	220
WS040280	28	20	610	280

## WS05 Rd 螺纹预埋吊索

### WS05 Rd-thread Lift Loop



Part No.	d*e(mm)	Ø (mm)	Load(ton)	Height(mm)
WS050060	Rd12*22	6	0.5	155
WS050070	Rd14*24	7	0.8	155
WS050080	Rd16*27	8	1.2	155
WS050100	Rd20*35	10	2	215
WS050160	Rd30*50	16	4	300
WS050180	Rd36*65	18	6.3	340
WS050200	Rd42*70	20	8	425
WS050260	Rd52*80	26	12.5	480

## WS06 M 螺纹 预埋吊索

### WS06 M-thread Lift Loop



Part No.	d*e(mm)	Load(ton)	Height(mm)	Width(mm)
WS060060	M12*22	6	0.5	155
WS060070	M14*24	7	0.8	155
WS060080	M16*27	8	1.2	155
WS060100	M20*35	10	2	215
WS060160	M30*50	16	4	300
WS060180	M36*65	18	6.3	340
WS060200	M42*70	20	8	425
WS060260	M52*80	26	12.5	480

## 铝套压制绳圈

### WS20 Endless Locking Type(6x37+IWRC)



Part No.	Rope Dia (mm)	Working Load Limited(Ton)					
		Vertical	Choker	Basket Hitches			
WS200100	10	2.1	1.6	4.2	3.7	2.9	2.1
WS200120	12	3.2	2.3	6.3	5.5	4.4	3.2
WS200140	14	4	3	8	7	6	4
WS200160	16	5	4	11	9	7	5
WS200180	18	7	5	13	12	9	7
WS200200	20	8	6	16	14	11	8
WS200220	22	10	7.5	20	17	14	10
WS200240	24	12	9	24	21	17	12
WS200260	26	14	11	29	25	20	14
WS200280	28	17	13	33	29	23	17
WS200300	30	19	14	38	33	27	19
WS200320	32	21	16	42	37	30	21
WS200340	34	24	18	48	42	34	24
WS200360	36	27	20	54	47	38	27
WS200380	38	30	23	60	52	42	30
WS200400	40	34	26	68	60	47	34
WS200420	42	37	28	74	65	52	37
WS200450	45	43	33	86	75	60	43
WS200500	50	53	40	106	93	74	53
WS200520	52	56	43	112	99	78	56
WS200560	56	66	50	132	117	93	66
WS200600	60	76	58	152	134	107	76
WS200650	65	89	68	179	157	125	89
WS200700	70	104	79	208	183	146	104
WS200750	75	119	90	237	209	166	119
WS200780	78	129	98	257	226	180	129
WS200820	82	142	108	285	251	199	142
WS200870	87	156	119	313	275	219	156
WS200920	92	179	136	358	315	250	179
WS200950	95	191	145	382	336	267	191
WS201000	100	203	154	406	357	284	203
WS201020	102	219	167	438	386	307	219
WS201050	105	232	176	463	408	324	232

\* WLL=MBL X 0.9 (Pressing Efficiency of Aluminum Ferrules)/5 (Safety Factor)

## WS21无接头绳圈

### WS21 Endless Wire Rope Slings

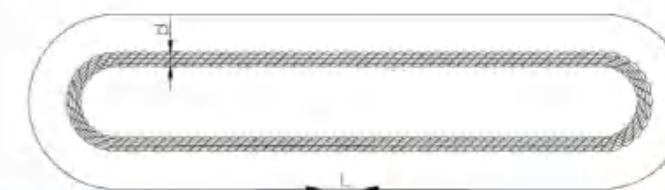

Part No.	Nominal dia. d (mm)	Breaking load (KN)	Vertical working load of single leg (KN)	Working load of double leg (KN)		Working load of four leg (KN)		Approx. weight (kg/m)	
			$\alpha=0^\circ$	$\alpha \leq 45^\circ$	$45^\circ \leq \alpha \leq 90^\circ$	$\alpha \leq 45^\circ$	$45^\circ \leq \alpha \leq 90^\circ$		
WS210100	10	60	10	18	14	36	28	0.29	
WS210120	12	100	16	30	22	60	44	0.48	
WS210150	15	140	23	41	32	82	64	0.71	
WS210180	18	180	30	54	42	108	84	0.98	
WS210210	21	235	39	70	55	140	110	1.11	
WS210240	24	305	51	92	70	184	140	1.44	
WS210270	27	385	64	115	90	230	180	1.82	
WS210300	30	475	79	142	110	284	220	2.25	
WS210360	36	605	114	205	160	410	320	3.39	
WS210420	42	930	155	280	217	560	434	4.61	
WS210480	48	1220	203	365	284	730	568	6.02	
WS210540	54	1540	256	460	358	920	716	7.62	
WS210600	60	1900	316	570	442	1140	884	9.38	
WS210660	66	2305	384	690	538	1380	1076	11.36	
WS210720	72	2745	458	824	640	1648	1280	13.53	
WS210780	78	3220	536	964	750	1928	1500	15.91	
WS210840	84	3730	622	1120	870	2240	1740	18.43	
WS210900	90	4285	714	1285	1000	2570	2000	21.15	
WS210960	96	4880	812	1462	1136	2924	2274	24.07	
WS211020	102	5510	918	1652	1285	3304	2570	27.20	
WS211080	108	6175	1030	1854	1442	3708	2884	30.46	
WS211140	114	6875	1146	2062	1604	4124	3208	34.00	
WS211200	120	7615	1270	2286	1778	4572	3556	37.67	
WS211260	126	8400	1400	2520	1960	5040	3920	41.48	
WS211320	132	9210	1535	2763	2150	5526	4300	45.56	
WS211380	138	10032	1672	3010	2340	6020	4680	49.78	
WS211440	144	10945	1824	3282	2554	6564	5108	54.20	
WS211500	150	11855	1976	3556	2766	7112	5532	58.82	
WS211560	156	12860	2144	3860	3002	7720	6004	63.65	
WS211620	162	13860	2310	4158	3234	8316	6468	68.68	
WS211680	168	14955	2492	4486	3488	8972	6976	74.12	
WS211740	174	16050	2675	4815	3745	9630	7490	78.88	
WS211800	180	17145	2858	5144	4000	10288	8000	85.00	
WS211860	186	17600	2934	5282	4108	10564	8216	94.52	
WS211920	192	18695	3116	5608	4362	11216	8724	100.6	
WS211980	198	19800	3300	5940	4620	11880	9240	106.8	
WS212040	204	21160	3526	6346	4936	12692	9872	113.6	
WS212100	210	22345	3724	6702	5214	13404	10428	120.4	
WS212160	216	23710	3950	7110	5530	14220	11060	127.2	
WS212220	222	24990	4165	7498	5830	14995	11660	134.6	
WS212280	228	26355	4392	7906	6150	15812	12300	142.1	
WS212340	234	27815	4636	8345	6490	16690	12980	149.6	
WS212400	240	29275	4880	8784	6832	17568	13664	157.1	

Note: Safety factor 6:1 . . . for use in general frequent lifting environment.

## WS22 大直径钢缆绞接索具 WS22 Large Diameter Cable-Laid Slings

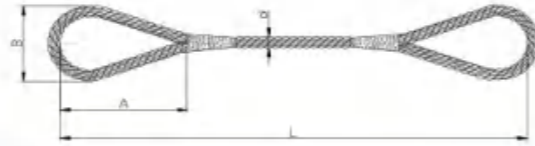

Part No.	Nominal dia. d (mm)	Main rope dia. (mm)	Core rope dia. (mm)	Breaking load		Working load limit		Approx. weight (kg/m)
				(KN)	(t)	(KN)	(t)	
WS220700	70	22	26	1460	149	304	31	15.62
WS220760	76	24	28	1736	177	373	38	18.54
WS220820	82	26	30	2039	208	451	46	21.67
WS220900	90	28	34	2363	240	539	55	25.61
WS220960	96	30	36	2713	277	647	66	29.24
WS221020	102	32	38	3089	315	756	77	33.15
WS221080	108	34	40	3486	355	882	90	37.28
WS221140	114	36	42	3905	398	1022	104	41.69
WS221200	120	38	44	4363	445	1182	120	46.32
WS221260	126	40	46	4838	493	1360	139	51.18
WS221320	132	42	48	5314	542	1551	158	56.27
WS221440	144	46	52	6394	652	2022	206	67.24
WS221500	150	48	54	6955	709	2295	234	73.13
WS221560	156	50	56	7517	767	2506	256	78.90
WS221620	162	52	58	8165	833	2722	278	85.59
WS221680	168	54	60	8770	894	2923	298	92.17
WS221740	174	56	62	9461	965	3154	322	98.96
WS221800	180	58	64	10152	1035	3384	345	106.28
WS221920	192	62	68	11578	1181	3859	394	121.12
WS222040	204	66	72	13133	1339	4378	446	136.79
WS222160	216	68	80	13954	1423	4651	474	149.00
WS222280	228	74	80	16502	1683	5500	560	171.59
WS222400	240	76	88	17410	1775	5803	592	184.97
WS222520	252	80	92	19310	1969	6437	656	205.03
WS222640	264	84	96	21254	2167	7085	722	225.20
WS222760	276	88	100	23328	2379	7776	793	246.83
WS222880	288	90	108	24408	2489	8136	830	265.53
WS223000	300	96	108	26525	2705	8842	902	294.38
WS223120	312	100	112	28771	2934	9591	978	319.14
WS223360	336	108	120	32616	3326	10866	1108	383.31
WS223600	360	116	128	37627	3837	12542	1280	441.30
WS223840	384	124	136	42984	4383	14328	1460	503.59
WS224080	408	130	148	47088	4802	15696	1600	560.43
WS224320	432	138	156	53136	5418	17712	1806	629.93
WS224560	456	146	164	56592	5771	18864	1924	705.58

Note:

1. Steel wire ropes with diameters from Ø67 to Ø456 are 6×36WS+IWR, 6×65WS+IWR types complying to the GB/T20118 and GB/T20067 standards.
2. Large diameter steel cable twisting joint riggings are manufactured according to the EN13414 standard, and the safety factor should be selected according to the EN13414 standard.

## WS31 单腿成套压制索具 WS31 Single-leg Swaged Sling Assembly

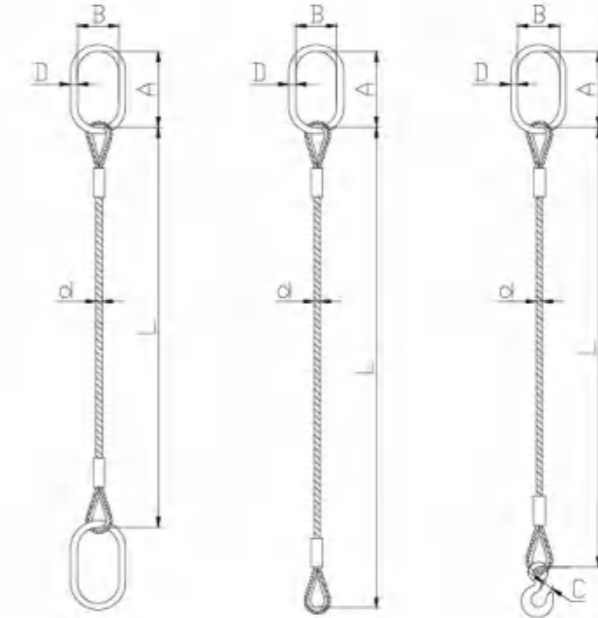
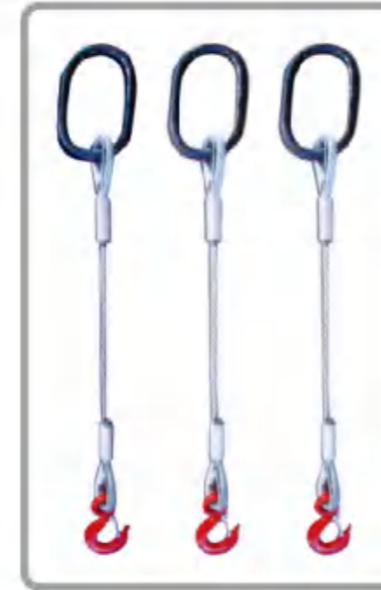

Part No.	Rope dia.(mm)	Working load limit (KN)	Loop dimension A×B×D (mm)	Dimension of hook opening C (mm)
WS310060	6	2.90	110x60x14	24
WS310080	8	4.90	110x60x14	24
WS310100	10	7.90	110x60x14	24
WS310120	12	11.80	110x60x16	25
WS310140	14	15.70	110x60x16	27
WS310160	16	21.60	135x75x18	30
WS310180	18	26.50	135x75x18	38
WS310200	20	32.40	160x90x22	38
WS310240	24	49.00	160x90x22	38
WS310280	28	68.60	180x100x26	45
WS310320	32	88.30	200x110x32	61
WS310380	38	117.70	260x140x36	67
WS310400	40	132.40	260x140x36	67
WS310440	44	147.00	300x160x40	67
WS310520	52	216.00	350x190x50	87
WS310560	56	257.00	350x190x50	87
WS310640	64	335.00	400x200x56	108
WS310700	70	400.00	400x200x56	108

Note:

1. The steel wire ropes are 1670N/mm<sup>2</sup> fiber core type.
2. "L" value meets client requirements.

## WS32 双腿成套压制索具

### WS32 Double-leg Swaged Sling Assembly

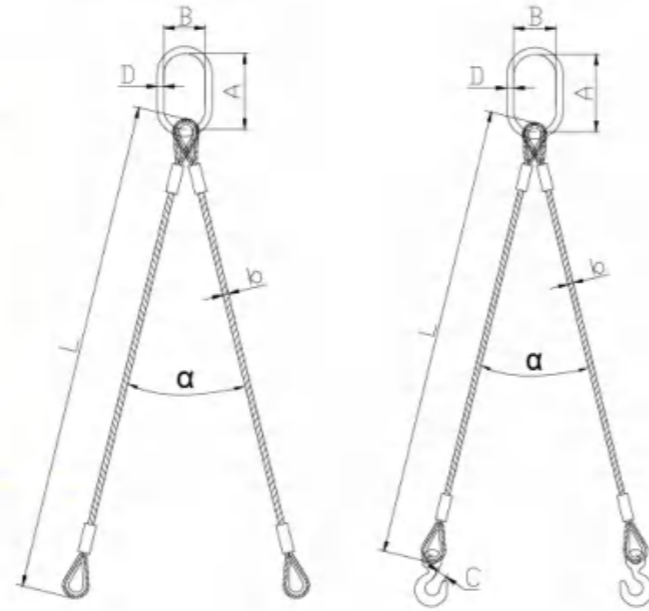

Part No.	Rope dia. (mm)	Working load limit (KN) $\alpha \leq 90^\circ$	Working load limit (KN) $90^\circ \leq \alpha \leq 120^\circ$	Loop dimension A×B×D (mm)	Dimension of hook opening C (mm)
WS320060	6	4.10	2.90	110x60x14	24
WS320080	8	6.90	4.90	110x60x14	24
WS320100	10	11.00	7.90	110x60x16	25
WS320120	12	16.50	11.80	110x60x16	25
WS320140	14	22.00	15.70	135x75x18	27
WS320160	16	30.00	21.60	135x75x18	30
WS320180	18	37.00	26.50	160x90x22	38
WS320200	20	45.00	32.40	160x90x22	38
WS320240	24	68.60	49.00	180x100x26	45
WS320280	28	96.00	68.60	200x110x32	61
WS320320	32	123.60	88.30	260x140x36	66
WS320380	38	165.00	117.70	300x160x40	87
WS320400	40	185.00	132.40	340x180x45	87
WS320440	44	206.00	147.00	340x180x45	87
WS320520	52	302.40	216.00	350x190x50	102
WS320560	56	359.80	257.00	400x200x56	107
WS320640	64	469.00	335.00	430x220x63	121
WS320700	70	560.00	400.00	460x250x72	146

Note:

1. The steel wire ropes are 1670N/mm<sup>2</sup> fiber core type.
2. "L" value meets client requirements.

## WS33 四腿成套压制索具

### WS33 Four-leg Swaged Sling Assembly

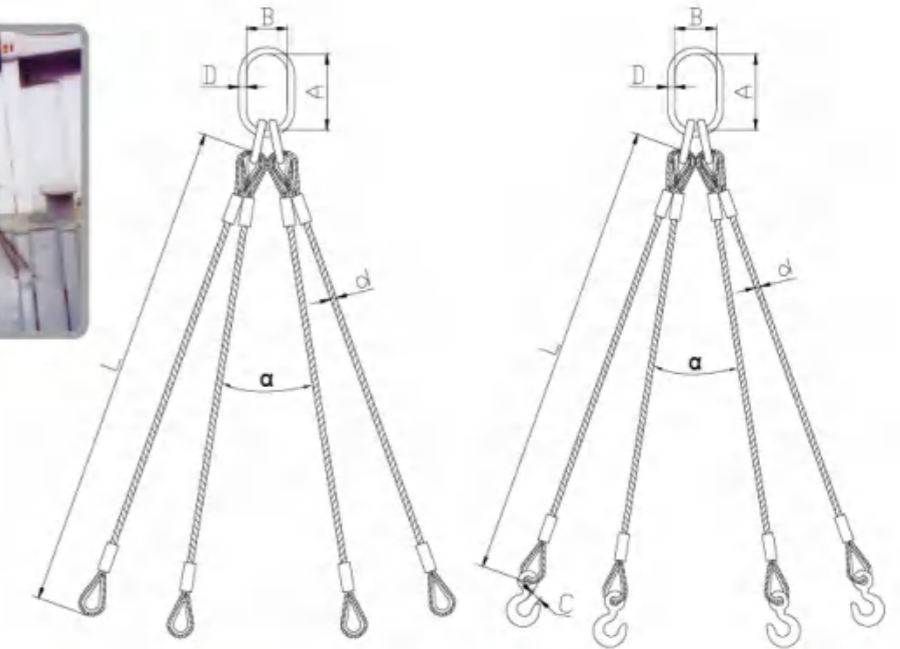

Part No.	Rope dia. (mm)	Working load limit (KN) $\alpha \leq 90^\circ$	Working load limit (KN) $90^\circ \leq \alpha \leq 120^\circ$	Main loop dimension A×B×D (mm)	Assistant loop dimension A×B×D (mm)	Dimension of hook opening C (mm)
WS330060	6	6.10	4.40	100x60x14	85x40x12	24
WS330080	8	10.30	7.40	100x60x14	85x40x12	25
WS330100	10	16.60	11.90	100x60x14	85x40x12	27
WS330120	12	24.80	17.70	160x90x18	100x60x14	30
WS330140	14	33.00	23.60	160x90x20	100x60x14	38
WS330160	16	45.40	32.40	180x100x22	150x70x18	38
WS330180	18	55.70	39.80	180x100x22	150x70x18	45
WS330200	20	68.00	48.60	270x140x28	160x90x22	45
WS330240	24	102.90	73.50	270x140x32	180x100x25	61
WS330280	28	144.10	102.90	260x140x36	—	66
WS330320	32	185.40	132.50	340x180x45	—	87
WS330380	38	247.00	176.60	340x180x50	—	102
WS330400	40	278.00	199.00	340x180x50	—	102
WS330440	44	309.00	221.00	340x180x50	—	108
WS330520	52	450.00	324.00	430x220x63	—	121
WS330560	56	540.00	386.00	460x250x72	—	146

Note:

1. The steel wire ropes are 1670N/mm<sup>2</sup> fiber core type.
2. "L" value meets client requirements.



## Cable Socks

Cable Socks is a woven wire rope sleeve with an eye or more eyes at the end, the sleeve is designed to fit onto a wire rope or cable to become an attachment point for hauling, or for securing the wire rope or cable during installation.

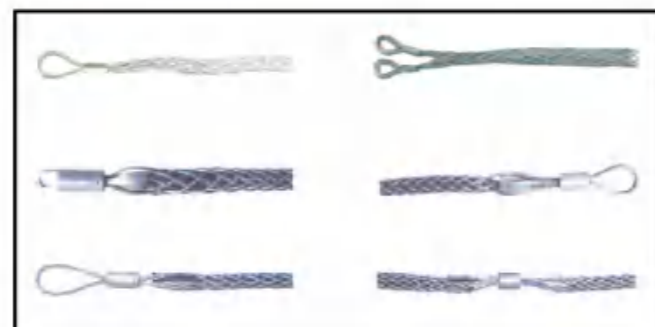

## 单拉眼电缆网套 Single Eye Cable Socks

Part No.	HOSE OD (MM)	ROPE STRANDS	SIZE (mm)			BREAKING LOAD (KGS)
			E	L	OVERALL LENGTH	
SL610016	13-16	Double strands	112	534	646	1836
SL610019	16-19		130	610	740	2286
SL610025	19-25		130	610	740	2777
SL610038	25-38		130	610	740	3920
SL610050	38-50		130	610	740	6697
SL610063	50-63		130	610	740	7551
SL610076	63-76		130	610	740	10004
SL610089	78-89		130	610	740	10004
SL610102	89-102		140	660	800	12659



## 双拉眼电缆网套 Double Eyes Cable Socks

Part No.	HOSE OD (MM)	ROPE STRANDS	SIZE (mm)			BREAKING LOAD (KGS)
			E	L	OVERALL LENGTH	
SL63S020	15-20	Single Strand	250	1250	1500	1116
SL63S030	20-30	Single Strand	250	1250	1500	1377
SL63D030	20-30	Double strands	250	1250	1500	1791
SL63S040	30-40	Single Strand	250	1250	1500	2295
SL63D040	30-40	Double strands	250	1250	1500	2754
SL63D050	40-50		250	1500	1750	5337
SL63D060	50-60		250	1500	1750	5967
SL63D070	60-70		250	1500	1750	7011
SL63D090	70-90		250	1500	1750	7299
SL63D110	90-110		250	1500	1750	10647
SL63D130	110-130		250	1500	1750	10647
SL63D150	120-150		250	1500	1750	11475
SL63D180	140-180		250	1500	1750	11475



## 侧拉型电缆网套 Side Pull Type Cable Socks

Part No.	HOSE OD (MM)	ROPE STRANDS	SIZE (mm)			BREAKING LOAD (KGS)	
			E	L	OVERALL LENGTH	GALVANIZED WIRE ROPE	STAINLESS STEEL WIRE ROPE
SL64S013	6-13	Single Strand	75	230	305	684	549
SL64S019	13-19		75	355	430	914	729
SL64S025	19-25		105	405	510	2286	1827
SL64S038	25-38	Double strands	155	455	610	3200	2561
SL64D050	38-50		200	535	735	4572	3659
SL64D063	50-63		255	610	865	4572	3659
SL64D089	63-89		305	685	990	5486	4388
SL64D115	89-115		305	685	990	6399	5121
SL64D140	115-140		305	685	990	6389	5121



## 双头旋转电缆网套 Double Eyes Swivel Cable Socks

Part No.	HOSE OD (MM)	OVERALL LENGTH (mm)	CONSTRUCTION	WIRE ROPE DIA (mm)	W.L.L (kg)
SL650014	8-14	400	4*3	1.2	800
SL650020	14-20	550	4*3	1.2	800
SL650030	20-30	640	6*2	1.5	1000
SL650040	30-40	870	6*2	2.0	1500
SL650050	40-50	1150	6*2	2.5	2500
SL650060	50-60	1250	6*2	2.5	2500
SL650070	60-70	1300	6*2	2.5	2500
SL650085	70-85	1350	6*2	3.0	2800
SL650100	85-100	1850	7*2	3.0	3000
SL650120	100-120	2000	7*2	3.0	3000
SL650140	120-140	2200	8*2	3.0	3500



## 镀锡铜吊网 Tin Plated Copper Cable Pulling Grip Socks

Part No.	HOSE OD (INCH)	OVERALL LENGTH (mm)	CONSTRUCTION	WIRE ROPE DIA (mm)	W.L.L (kg)
SL660099	0.79-0.99"	530	6*1	1.0	300
SL660124	1.0-1.24"	580	6*1	1.2	400
SL660149	1.25-1.49"	630	6*1	1.5	600
SL660174	1.50-1.74"	750	6*1	1.5	600
SL660199	1.75-1.99"	840	7*1	1.5	800
SL660249	2.0-2.49"	940	8*1	1.5	1000
SL660299	2.5-2.99"	1050	10*1	1.5	1200
SL660349	3.0-3.49"	1100	11*1	1.5	1300
SL660399	3.5-3.99"	1100	12*1	1.5	1500



## 预绞式拉线耐张线夹 Preformed Dead End Grips

### 1. Type, Function and Construction

There are many types of grips, including common ones, adjustable ones, ones used in fixing large tower and microwave tower etc.

The construction of dead end grip is very simple. Two legs of preformed armour rods twist to form hollow pipe and the other end forms ground loop. When the hollow pipe twine on the wire, it will generate strong grasping force.

The ground loop is fixed on the ground anchor or tower.

### 2. Features

- 1) High strength: each dead end grip has an extra length to guarantee that the grasping force can be over the rated breaking strength of the Guy Wire.
- 2) Good corrosion resistance: Material is the exact same as wire to prevent the electric corrosion between wire and grip.
- 3) Easy for installation: All dead end grips can be performed easily by hand by a man without any help of other special tools.
- 4) Installation quality can be easily guaranteed. Installation quality can be inspected by eyes not by special skills. The appearance is pretty good.
- 5) Multiple purpose. Dead end grips can be used with many kinds of fittings( see the installation instruction). With using 1 inch diameter wire, the heavy duty grips and adjustable grips could meet the requirements of the larger towers.
- 6) Fully security: there are anti-theft rings to prevent the grips from steal.

The Preformed Dead End Grip is used for guy wire







CODE	CROSS-SECTIONAL AREA (mm <sup>2</sup> )	GUY WIRE DIAMETER (mm)	REFERENCE LENGTH (mm)	NUMBER OF WIRES	WEIGHT KG/PC
NL-25/G	25	6.60	635	5	0.2
NL-35/G	35	7.80	711	5	0.3
NL-50/G	50	9.00	901	5	0.5
NL-70/G	70	11.00	1016	5	0.8
NL-95/G	95	12.50	1333	5	1.7
NL-100/G	100	13.00	1333	5	1.7
NL-120/G	120	14.00	1460	5	2.2

Note : "N" refers to Dead End Grip, "L" refers to Spiralism Preformed Dead End Grip  
After "." refers to the code of the Guy Wire.

## 扁平吊装带 Flat Webbing Sling

1. High tensile polyester material
2. According to EN1492-1:2000
3. With reinforced lifting eyes
4. Safety factor 7:1
5. Low elongation
6. Wear resistant
7. Other safety factors are available: 5:1, 6:1, 8:1
8. Other width is also available
9. Single ply or double plies
10. According to machinery directive 2006/42/EC

### Lifting eye types

Flat eye	
Reversed eye	
Folded eye width from 1 side	
Folded eye width from 2 side	
Folded eye 1/3 width	

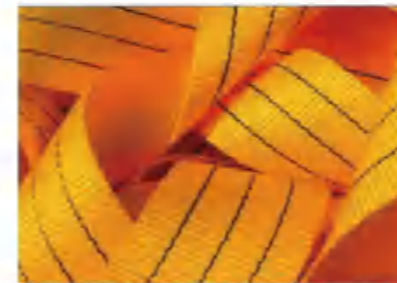

Webbing Width (SF: 7:1) mm	Colour coded according to EN 1492-1	Working load limited with 1 webbing sling (kgs)					Working load limited with 2 webbing sling (kgs)			
		Straight lift	Choked lift	β			Straight lift up to 45°	Choked lift up to 45°	Straight lift 45-60°	Choked lift 45-60°
				0° - 7°	7° - 45°	45° - 60°				
10		1.0	0.8	2.0	1.4	1.0	1.4	1.12	1.0	0.8
30	WLL1T	1.000	8.000	2.000	1.400	1.000	1.400	1.120	1.000	8.000
60	WLL2T	2.000	1.600	4.000	2.800	2.000	2.800	2.240	2.000	1.600
90	WLL3T	3.000	2.400	6.000	4.200	3.000	4.200	3.360	3.000	2.400
120	WLL4T	4.000	3.200	8.000	5.600	4.000	5.600	4.480	4.000	3.200
150	WLL5T	5.000	4.000	10.000	7.000	5.000	7.000	5.600	5.000	4.000
180	WLL6T	6.000	4.800	12.000	8.400	6.000	8.400	6.720	6.000	4.800
240	WLL8T	8.000	6.400	16.000	11.200	8.000	11.200	8.960	8.000	6.400
300	WLL10T	10.000	8.000	20.000	14.000	10.000	14.000	11.200	10.000	8.000

## 圆圈带 Endless Webbing Sling

1. High tensile polyester material
2. Safety factor are available 5:1,6:1,7:1
3. Low elongation
4. Wear resistant
5. According to EN1492-1 2000
6. Single ply or double plies
7. According to machinery directive 2006/42/EC

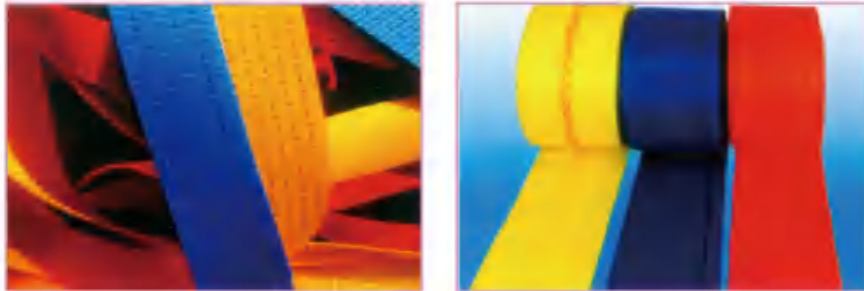

## 圆套带 Round Sling

1. High tensile polyester material
2. According to EN1492-1:2000
3. Safety factor 7:1
4. Each stripe is equal to 1 ton capacity
5. Low elongation
6. Flexible and wear resistant
7. The safe working load is clearly printed on the sleeve
8. Other safety factors are available: 5:1, 6:1, 8:1
9. Single ply or double plies sleeves
10. According to machinery directive 2006/42/EC

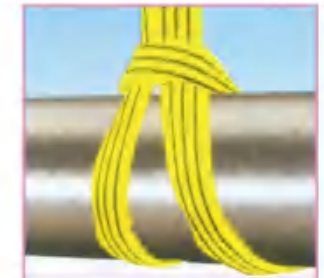

Webbing width (mm)	Colour coded according to EN 1492-1	Working load limited with 1 webbing sling (kgs)						Working load limited with 2 webbing sling (kgs)				
		Straight lift	Choked lift	β				Straight lift up to 45°	Choked lift up to 45°	Straight lift 45-60°	Choked lift 45-60°	
				0° -7°	7° -45°	45° -60°	up to 45°					45° -60°
30	WLL1T	1.000	0.800	2.000	1.400	1.000	0.700	0.500	1.400	1.120	1.000	0.800
60	WLL2T	2.000	1.600	4.000	2.800	2.000	1.400	1.000	2.800	2.240	2.000	1.600
90	WLL3T	3.000	2.400	6.000	4.200	3.000	2.100	1.500	4.200	3.360	3.000	2.400
120	WLL4T	4.000	3.200	8.000	5.600	4.000	2.800	2.000	5.600	4.480	4.000	3.200
140	WLL5T	5.000	4.000	10.000	7.000	5.000	3.500	2.500	7.000	5.600	5.000	4.000
180	WLL6T	6.000	4.800	12.000	8.400	6.000	4.200	3.000	8.400	6.720	6.000	4.800
240	WLL8T	8.000	6.400	16.000	11.200	8.000	5.600	4.000	11.200	8.960	8.000	6.400
300	WLL10T	10.000	8.000	20.000	14.000	10.000	8.400	6.000	14.000	11.200	10.000	8.000

Webbing width (mm)	Colour coded according to EN 1492-1	Working load limited with 1 webbing sling (kgs)						Working load limited with 2 webbing sling (kgs)				
		Straight lift	Choked lift	β				Straight lift up to 45°	Choked lift up to 45°	Straight lift 45-60°	Choked lift 45-60°	
				0° -7°	7° -45°	45° -60°	up to 45°					45° -60°
25	WLL1T	1.000	0.800	2.000	1.400	1.000	0.700	0.500	1.400	1.120	1.000	0.800
50	WLL2T	2.000	1.600	4.000	2.800	2.000	1.400	1.000	2.800	2.240	2.000	1.600
75	WLL3T	3.000	2.400	6.000	4.200	3.000	2.100	1.500	4.200	3.360	3.000	2.400
100	WLL4T	4.000	3.200	8.000	5.600	4.000	2.800	2.000	5.600	4.480	4.000	3.200
125	WLL5T	5.000	4.000	10.000	7.000	5.000	3.500	2.500	7.000	5.600	5.000	4.000
150	WLL6T	6.000	4.800	12.000	8.400	6.000	4.200	3.000	8.400	6.720	6.000	4.800
200	WLL8T	8.000	6.400	16.000	11.200	8.000	5.600	4.000	11.200	8.960	8.000	6.400
250	WLL10T	10.000	8.000	20.000	14.000	10.000	8.400	6.000	14.000	11.200	10.000	8.000

Colour	Colour coded according to EN 1492-1	Working load limited with 1 webbing sling (kgs)						Working load limited with 2 webbing sling (kgs)				
		Straight lift	Choked lift	β				Straight lift up to 45°	Choked lift up to 45°	Straight lift 45-60°	Choked lift 45-60°	
				0° -7°	Bs7°	7° -45°	45° -60°					45° -60°
紫色	WLL1T	1.000	0.800	2.000	1.400	1.000	0.700	0.500	1.400	1.120	1.000	0.800
绿色	WLL2T	2.000	1.600	4.000	2.800	2.000	1.400	1.000	2.800	2.240	2.000	1.600
黄色	WLL3T	3.000	2.400	6.000	4.200	3.000	2.100	1.500	4.200	3.360	3.000	2.400
灰色	WLL4T	4.000	3.200	8.000	5.600	4.000	2.800	2.000	5.600	4.480	4.000	3.200
红色	WLL5T	5.000	4.000	10.000	7.000	5.000	3.500	2.500	7.000	5.600	5.000	4.000
棕色	WLL6T	6.000	4.800	12.000	8.400	6.000	4.200	3.000	8.400	6.720	6.000	4.800
蓝色	WLL8T	8.000	6.400	16.000	11.200	8.000	5.600	4.000	11.200	8.960	8.000	6.400
桔黄	WLL10T	10.000	8.000	20.000	14.000	10.000	7.000	5.000	14.000	11.200	10.000	8.000
桔黄	WLL12T	12.000	9.600	24.000	16.800	12.000	8.400	6.000	16.800	13.440	12.000	9.600

## Jacket Sling

Round Sling is covered with the jacket to protect the inside of ropes and prevent damaging.



## Guard

Guard as method of perfect protection could be applied to Rope as well as Roundsling. Guard will prevent Rope as well as Roundsling from abrasion and the life time of ropes and sling will be longer with perfection.



## Safety Self-Check Sling

Safety Self-Check sling with Ultra High Molecular Weight Polyethylene(UHMWPE) could check the life time of Round Sling.

UHMWPE Yarn Specification: 1600D, 32CN/dtex

- Melting Point : 150°C
- Temperature Range for USE : -40°C to 70°C
- Elongation at Break : 4 ~ 5%
- Specific Gravity : 0.97 (Float)
- Water Proportion : None (Wet strength equals Dry strength)
- Strongest fiber rope, maximum strength to weight ratio and strength comparable to steel wire rope.

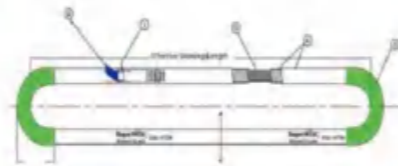

## 捆绑带 Cargo Lashing



Lashing system 25A

Lashing system 35B



Lashing system 50B



Part No.	Type	Lashing capacity(LC)in accordance with EN 12195-2(daN)	Webbing width (mm)	End fittings(No.)
HQCL25A2	25A/2	300	25	2,3,4,5
HQCL25A1	25A/1	300	25	环形 Loop
HQCL25B2	25B/2	500	25	2,3,4,5
HQCL25B1	25B/1	500	25	环形 Loop
HQCL35A2	35A/2	1000	35	1,2
HQCL35A1	35A/1	1000	35	环形 Loop
HQCL35B2	35B/2	1500	35	1,3,6,8,9,10
HQCL35B1	35B/1	1500	35	环形 Loop
HQCL50A2	50B/2	2000	50	1,3,4,6,8,9,10
HQCL50A1	50B/1	2000	50	环形 Loop
HQCL50B2	50A/2	2500	50	1,3,6,8,9,10
HQCL50B1	50A/1	2500	50	环形 Loop
HQCL75A2	75/2	5000	75	1,2,6,10
HQCL75A1	75/1	5000	75	环形 Loop
HQCL100B2	100/2	5000	100	1,2,6,10
HQCL100B1	100/1	5000	100	环形 Loop



## 捆绑带 Ratchet Tie Down

0.8t, 25-08-4m

25mm Cam buckle  
Length:4m



Lashing Capacity(LC)



400kgs   
800kgs 

1t, 25-10-6m

25mm Ratchet buckle, Double J hooks  
Length:6m



Lashing Capacity(LC)



500kgs   
1000kgs 

1t, 25-10-4m

25mm Ratchet buckle, S hooks  
Length:4m



Lashing Capacity(LC)

500kgs   
1000kgs 

1.5t, 25-15-6m

25mm Ratchet buckle, S hooks  
Length:6m



Lashing Capacity(LC)

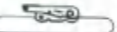

750kgs   
1500kgs 

1.5t, 25-10-6m

25mm Ratchet buckle, S hooks  
Length:6m



Lashing Capacity(LC)



500kgs   
1000kgs 

2t, 35-20-6m

35mm Ratchet buckle,  
Double J hooks  
Length:6m



Lashing Capacity(LC)



1000kgs   
2000kgs 

3t, 35-30-6m

35mm Ratchet buckle, Single hooks  
Length:6m



Lashing Capacity(LC)



1500kgs   
3000kgs 

5t, 50J-50-4m

50mm Ratchet buckle,  
Single hook and swivel hook  
Length:4m



Lashing Capacity(LC)



2500kgs   
5000kgs 

4t, 50E-40-8m 50-40-8m

50mm Ratchet buckle, E spring fittings  
Length:8m



Lashing Capacity(LC)



2000kgs   
4000kgs 

5t, 50-50-9m

50mm Reverse Ratchet buckle,  
Hooks and keepers  
Length:9m



Lashing Capacity(LC)



2500kgs   
5000kgs 

5t, 50-50-10m

50mm Ratchet buckle, Double J Hooks  
Length:10m



Lashing Capacity(LC)

2500kgs   
5000kgs 

## C型液压钢丝绳压套机 SM50C/SM150C/SM260C SM400C/SM600C/SM1000C

### C-Type Hydraulic Swaging Machine SM50C/SM150C/SM260C/SM400C/SM600C/SM1000C

#### Structure and Characteristic

- 1.The C-Type bodies are made of one piece casting alloy steel, it makes the H-Quality Swaging Machine more durable and stronger.
- 2.Equipped with high pressure and low pressure oil pumps, the H-Quality Swaging Machine can steady load and unload so that the swaging quality is improved.
- 3.The dies are fully accessible in C-Type bodies design,allowing the rigger freely moves the slings around the swaging area.



#### 主要技术规格参数 Major Technique Specification and Parameter

Model	SM50C	SM150C	SM260C	SM400C	SM600C	SM1000C
Capacity	500kN	1500kN	2600kN	4000kN	6000kN	10000kN
Press range	1-5mm	6-14mm	6-18mm	6-26mm	6-34mm	16-44mm
Max.diameter (Multi-pressing)	6mm	16mm	22mm	28mm	40mm	48mm
Voltage & frequency	380V 50Hz Or As request					
Power	3kW	3kW	4kW	7.5kW	7.5kW	7.5kW
Max. Pressure	63Mpa	63Mpa	63Mpa	63Mpa	63Mpa	63Mpa
Control pressure	10Mpa	10Mpa	10Mpa	10Mpa	10Mpa	10Mpa
Working stroke	25mm	50mm	70mm	90mm	120mm	140mm
Piston working speed	12mm/s	10mm/s	8mm/s	8mm/s	8mm/s	7mm/s
Dimension (L*W*H)	1500 * 650 * 1550	900 * 530 * 1400	1100 * 640 * 1450	1280 * 800 * 1650	1250 * 1128 * 1919	1428 * 1400 * 2022
Weight (Approx.)	340kg	520kg	1600kg	3200kg	5200kg	6600kg

The exquisite technology, creates the perfect product

## 框架式液压钢丝绳压套机 SM600H/SM800H/SM1500/SM2000/SM3000/SM5000

### Frame Style Hydraulic Swaging Machine SM600H/SM800H/SM1500/SM2000/SM3000/SM5000

#### Structure and Characteristic

- With importing foreign advanced technology and new process and improving our years of production practice, H-Quality has developed a new generation of advanced wire rope swaging machine---Frame Hydraulhydraulic Swaging Machine.
- 1.The Frame are designed to use prestress wire rope wind-up technology, it distributes the stress around the frame homogeneously, and makes the Bodies never cracking.
  - 2.With guiding and sliding devices on the die seats, the upper and lower dies can be replaced conveniently.



#### 主要技术规格参数 Major Technique Specification and Parameter

Model	SM600H	SM800H	SM1500	SM2000	SM3000	SM5000
Capacity	6000kN	8000kN	15000kN	20000kN	30000kN	50000kN
Press range	6-34mm	16-38mm	16-56mm	32-65mm	32-86mm	Up to 110mm
Max.diameter (Multi-pressing)	40mm	48mm	60mm	70mm	96mm	120mm
Voltage & frequency	380V 50Hz Or As request					
Power	7.5kW	7.5kW	7.5kW *2	7.5kW *2	7.5kW *2	7.5kW *4
Max. Pressure	63Mpa	63Mpa	63Mpa	63Mpa	63Mpa	63Mpa
Control pressure	12Mpa	12Mpa	12Mpa	12Mpa	12Mpa	12Mpa
Working stroke	120mm	120mm	140mm	240mm	240mm	370mm
Piston working speed	9mm/s	8mm/s	7mm/s	8mm/s	7mm/s	9mm/s
Dimension (L*W*H)	900 * 530 * 1400	1400 * 950 * 2350	2000 * 1050 * 2750	2100 * 1300 * 3100	2200 * 1100 * 4400	2440 * 1270 * 5300
Weight (Approx.)	2800kg	5200kg	6800kg	11000kg	22000kg	56000kg
Noise Level	≤85dB					
Color	Blue or as request					

The exquisite technology, creates the perfect product